



Danish Ministry of the Environment
Environmental Protection Agency

Assessment of possible impacts of scrubber water discharges on the marine environment

Environmental Project No. 1431, 2012

Title:

Assessment of possible impacts of scrubber water discharges on the marine environment

Authors & contributors:

Jesper Kjølholt, Stian Aakre, Carsten Jürgensen, Jørn Lauridsen
COWI, Parallelvej 2, 2800 Lyngby

Publisher:

Miljøstyrelsen
Strandgade 29
1401 København K
www.mst.dk

Year:

2012

ISBN no.

978-87-92903-30-3

Disclaimer:

The Danish Environmental Protection Agency will, when opportunity offers, publish reports and contributions relating to environmental research and development projects financed via the Danish EPA. Please note that publication does not signify that the contents of the reports necessarily reflect the views of the Danish EPA. The reports are, however, published because the Danish EPA finds that the studies represent a valuable contribution to the debate on environmental policy in Denmark.

May be quoted provided the source is acknowledged.

Indhold

ABBREVIATIONS AND ACRONYMS	5
SUMMARY AND CONCLUSIONS	7
DANSK SAMMENDRAG	13
1 INTRODUCTION	19
1.1 OBJECTIVES	20
1.2 PROJECT ORGANISATION	20
1.3 PROJECT ACTIVITIES	20
2 LEGISLATIVE FRAMEWORK	21
3 OVERVIEW OF SCRUBBER SYSTEMS ON SHIPS	25
3.1 DESCRIPTION OF EXISTING SYSTEMS	25
3.1.1 SO _x scrubbers	26
3.1.2 EGR scrubbers (DeNO _x systems)	34
3.1.3 Inert gas cleaning scrubbers	36
3.1.4 Dry scrubbers	38
3.2 DISCHARGES, EMISSIONS AND WASTE	40
3.2.1 SO _x scrubbers	40
3.2.2 EGR scrubbers (DeNO _x systems)	43
3.2.3 Inert gas cleaning scrubbers	43
3.2.4 Dry scrubbers	43
3.3 NEAR FUTURE DEVELOPMENT OF SCRUBBERS	44
3.4 SUMMARY/COMPARATIVE ASSESSMENT	45
4 PRACTICAL INVESTIGATIONS	47
4.1 SYSTEM DESCRIPTION	47
4.2 INVESTIGATION PROGRAMME	48
4.2.1 Sampling	48
4.2.2 Chemical analyses	51
4.3 RESULTS AND DISCUSSION	52
4.3.1 Fuel analyses	52
4.3.2 Scrubber water, SW-mode	52
4.3.3 Scrubber water, FW-mode	55
4.3.4 Sludge, FW-mode	60
5 ASSESSMENT OF IMPACT ON THE MARINE ENVIRONMENT	63
5.1 OVERALL APPROACH AND DELIMITATIONS	63
5.2 FRAMEWORK OF THE ASSESSMENT	63
5.2.1 Impact scenarios	63
5.2.2 Impact types considered	64
5.2.3 Study areas	67
5.2.4 Ship traffic	69
5.3 MARINE IMPACT ASSESSMENT	74
5.3.1 "All ships" scenario	74
5.3.2 "One ship" scenario	80
5.3.3 "No scrubbers" scenario	82
5.3.4 Use of exhaust gas scrubbers in ports	83

6	SCRUBBER WASTE TREATMENT AND DISPOSAL	85
6.1	CHARACTERISTICS OF SCRUBBER SLUDGE	85
6.2	TREATMENT AND DISPOSAL OPTIONS	85
6.2.1	Waste classification	85
6.2.2	Waste treatment	87
6.2.3	Transport requirements	87
6.3	RECEPTION FACILITIES IN DANISH PORTS	88
7	LITERATURE	91

Abbreviations and acronyms

ADR	Agreement concerning the International Carriage of Dangerous Goods by Road
AIS	Automatic Information System (for ship traffic registration)
COD	Chemical oxygen Demand
ECA	Emission Control Area
EGC	Exhaust Gas Cleaning
EGR	Exhaust Gas Re-circulation
EQS	Environmental Quality Standard
FW	Fresh Water
HELCOM	Helsinki Commission
HFO	Heavy Fuel Oil
IMO	International Maritime Organization
LNG	Liquified Natural Gas
MARPOL	The International Convention for the Prevention of Pollution From Ships (MARine POLLution)
MCR	Maximum Continuous Rating (max. engine capacity)
MEPC	Marine Environment Protection Committee (under the IMO)
MW	Mega Watt
NO _x	Nitrogen oxides, e.g. nitrogen dioxide, NO ₂
OSPAR	Oslo and Paris Conventions for the protection of the marine environment of the North-East Atlantic
PCB	Polychlorinated biphenyls
PCDD/F	Polychlorinated dibenzodioxins and dibenzofurans
PAH	Polycyclic aromatic hydrocarbons
S	Sulphur
SCR	Selective Catalytic Reduction
SECA	Sulphur Emission Control Area
SO _x	Sulphur oxides, e.g. sulphur dioxide, SO ₂
SS	Suspended solids
SW	Salt Water
TCDD	2,3,7,8-tetrachloro-dibenzo-p-dioxin ("Seveso dioxin")
THC	Total (petroleum) hydrocarbons
UNEP	United Nations Environment Programme

Summary and conclusions

With the objective of significantly reducing air pollution from ships, the use of low sulphur fuel will be required internationally within few years. A possible alternative to this measure is cleaning of the exhaust gases in scrubbers but the possible marine environmental consequences arising from the use of scrubbers has not previously been studied in detail. This study was carried out in order to attain a more detailed assessment, which can add to the ongoing international evaluation of criteria for wash water from scrubbers. It was found that compared to current environmental acceptability levels the releases from scrubbers can be expected to be considerably below the levels of ecological concern. However, a risk assessment for any specific area must also take existing contamination levels and releases from other sources into account.

Background and objectives

In response to growing concerns about air pollution from ship traffic and its environmental consequences, the international society has through MARPOL gradually introduced initiatives addressing this issue, not least with regard to reduction of air emissions of sulphur dioxide and particulate matter.

Thus, a cap was put on sulphur content in marine fuels, both globally (3.5 % at present) and in the concept of SO_x Emission Control Areas (SECA) that further limit the content of sulphur in marine fuels (1 % at present) in particularly sensitive areas, e.g. the Baltic Sea and the North Sea. Later, the concept of SECA was redefined ECA (Emission Control Area) to open for also regulating other air emission parameters in the designated areas.

In 2015 the limit for sulphur in marine fuels will be lowered to 0.1 % in ECAs and there is concern that the use of low sulphur marine fuels will have significant economical consequences for shipowners especially in the emission control areas. MARPOL does, however, allow for the use of exhaust gas cleaning systems or other technologies to limit SO_x emissions to a level equivalent to that obtained by use of low sulphur fuel.

To address the concern that the use of scrubber systems could potentially have adverse effects on the marine environment the Danish EPA decided to initiate the current study with the main objective to assess the possible impacts of scrubber water discharges on the marine environment based on a practical investigation and a literature review.

The project

The project was carried out by COWI A/S during 2011 and consists of the following main components:

- A literature review presenting the relevant scrubber systems for ships and their principles of operation, advantages and drawbacks, and status with emphasis on wet scrubber systems for sulphur removal,
- practical investigations of pollutants in wash water and sludge from a scrubber system onboard a ro-ro carrier (the Ficaria Seaways having a

21 MW engine) able to operate in one-time-through mode with salt water and in circulation mode using fresh water,

- assessment of the possible impacts of scrubber water discharges on the marine environment exemplified by the Kattegat sea and the Bight of Aarhus for three scenarios: all ships use wet scrubbers for exhaust gas cleaning, all ships use low sulphur fuel instead of scrubbers, and local (acute) effects of one (big) ship with exhaust gas scrubber, and
- assessment of the current possibilities of scrubber sludge reception, treatment and disposal in Denmark.

Main conclusions

Based on the literature review, exhaust gas scrubbers for ships (wet scrubbers) appear to be able to effectively trap SO_x and also the majority of soot and other particles. In the scrubber SO_x is converted to sulphuric acid. Also a number of other pollutants (e.g. metals and PAH) occurring in the exhaust gas are trapped in the scrubber wash water, however to more varying degrees.

The study object of the practical investigations, the wet scrubber system installed on the ro-ro vessel Ficaria Seaways operating between Sweden, Norway and the UK, is considered suitable for the marine environmental assessment by representing well a (future) typical SO_x scrubber on an average ship in the Baltic Sea ECA.

Likewise, the two selected areas for marine pollution modeling, the Kattegat sea and the Aarhus Bight, are considered to represent well the two desired types of study areas for the marine assessment, i.e. an open sea area with high ship traffic intensity and a coastal, relatively confined and shallow area with significant traffic, respectively.

In the main impact scenario all ships > 2,000 tons dwt are equipped with scrubbers in 2015 and use high sulphur fuel (3.5 %). The results of the modeling for this scenario show that the impact of the discharges of acidic scrubber water (sulphuric acid) on the pH and buffering capacity of sea water in the Kattegat and in Aarhus Bight, respectively, will be negligible. This conclusion applies even to areas with significantly lower buffer capacity than the Kattegat (e.g. the Bay of Bothnia) and for a traffic intensity twice as high as the present.

Specific hazardous substances such as heavy metals and metalloids, polycyclic aromatic hydrocarbons (PAH), PCB and oil hydrocarbons will also be released with scrubber water. However, the resulting concentrations in the sea will be orders of magnitude below the levels of concern as expressed e.g. by EU's environmental quality standards (EQS) for the marine environment. Thus, the concentration of the most critical substances in relation to this criterion, the metals nickel and copper, will still be more than two orders of magnitude below the EQS.

The impact assessment of the specific hazardous substances was made as a generic assessment using the principles and acceptability criteria applied by the EU for assessment of chemicals in the aquatic environment and thus providing an overall marine assessment of the scrubber technology. This also implies that possible particular issues and rules relating to specific geographic areas (e.g. Natura 2000 areas), objectives of a more political nature, or

impacts of cumulative loads from other sources, are not comprised by the assessment.

The "one ship" scenario, intended to address the possible local short-term effects of the scrubber water discharge from a single ship, was based on the results from Ficaria Seaways (21 MW engine). The conclusion from the scenario is that the discharge of sulphuric acid is negligible compared to the capacity of the sea even in shallow areas and, further, that the specific hazardous substances will not reach levels anywhere close to the EQS for marine waters.

The "no scrubbers" scenario, assessed for comparison, shows of course that the impact of sulphur will be completely negligible but also that the concentrations of some metals occurring in fuels at levels varying proportionally with the sulphur content will be lower than in the "all ships" scenario. Other substances not exhibiting this proportionality will occur at levels resembling those in the "all ships" scenario.

The use of scrubbers on auxiliary engines and for inert gas production on tankers in ports with much ship traffic could, depending on the local conditions, in the longer term result in sea water concentrations of some substances at or close to the EQS value.

With regard to sludge produced by scrubbers operating in circulation mode using fresh water, it is concluded that facilities to receive, handle, transport, treat and dispose of such waste generally exist or can be made available in Danish ports.

Project results

Three main categories of (wet) scrubbers for ships exist:

- SO_x scrubbers (two types; flow-through using salt water and circulation using fresh water), also trapping particles and various substances,
- EGR scrubbers (Exhaust gas Re-circulation) with the main function of reducing NO_x but also reducing SO_x and particles, and
- inert gas scrubbers, which are essentially small SO_x scrubbers used to clean flue gas to be used as inert gas when emptying tankers.

A number of vendors exist but the marine use of scrubber systems are still considered to be at a relatively early stage of commercialisation in contrast to similar systems used in on-shore industrial installations where such system have been in use for more than 30 years.

The gaseous sulphur species, SO_x, are effectively trapped (> 90 %) in the scrubber water where they are converted immediately to sulphuric and sulphurous acid (the latter being oxidised further to sulphuric acid), which is neutralised in seawater, primarily by the bicarbonate system. Freshwater circulation systems typically add sodium hydroxide (NaOH) for neutralisation to prevent corrosion of pipes and tanks. Particles (PM) are trapped with considerably lower and more varying efficiency.

Discharge is direct from flow-through salt water systems and usually without removal of the trapped particles whereas in the fresh water circulation the particles are removed from the water phase, typically by centrifuging, thus giving rise to generation of sludge, which is later unloaded for treatment and/or disposal on-shore. The scrubber water itself can also be unloaded for on-shore treatment or can be discharged to the sea, however in smaller volumes than the salt scrubber water.

The practical investigations of scrubber water and sludge were carried out on the Ficaria Seaways (earlier Tor Ficaria) a 230 metres long, 14,500 tons dwt ro-ro carrier vessel with 21 MW 2-stroke engine), believed to represent a typical (future) scrubber system on a ship operating in the Baltic Sea ECA. The Ficaria Seaways is equipped with a dual SO_x scrubber system offering the possibility of operation in flow-through (salt water, SW) as well as circulation (fresh water, FW) mode.

Sampling of scrubber water was undertaken both in flow-through (SW) and circulation (FW) mode while the ship was operating at 85-90 % of max. engine capacity using fuels with two different contents of sulphur, 1.0 % and 2.2 %. In SW-mode samples were additionally taken at 40-45 % of max. engine capacity. In FW-mode sludge was sampled. Reference samples of both SW and FW and of both fuel types were included in the programme.

The reference and scrubber water samples were analysed for pH, total-N, total-S, COD, suspended solids, eight metals (arsenic, cadmium, copper, mercury, nickel, lead, vanadium and zinc), petroleum hydrocarbons (THC) and PAH (16 US EPA PAHs). The analytical programme for sludge also included PCBs and polychlorinated dioxins/furans (PCDD/F). Fuel was only analysed for the content of metals and sulphur.

Regarding fuel, it was found that the level of most of the metals was below the detection limit and only nickel and vanadium were present in quantifiable concentrations correlating with the content of sulphur.

The enrichment of nickel and vanadium was significant in flow-through scrubber water (SW) but even higher concentrations of copper and zinc were observed (up to 260 µg/L and 450 µg/L, respectively). These two metals were not detected in the fuel and their origin in the scrubber water remains unexplained although contamination from the tap used for sampling is suspected. An enrichment with sulphur was also observable as well as an effect on the pH, which increased with increasing sulphur content in the fuel. The levels of PAH and THC were low (the sum of PAH just exceeding 1 µg/L and THC at max. 330 µg/L).

When operating the scrubber using fresh water (circulation mode), the levels of pollutants as expressed through the suspended solids accumulated more or less linearly with time over a 2 hour period with sampling every 20 minutes. The point of saturation did, however, not appear to be reached within this time period. Significant enrichment was observed for most of the parameters and specific pollutants studied while for a few this could not be assessed with certainty due to rather high start concentrations in the water (residues from previous tank volume). Particularly high levels after 2 hours were observed for sulphur (max. 6,400 mg/L), vanadium (max. 17,000 µg/L), nickel (max. 4,500 µg/L) and THC (29,000 µg/L). The sum of PAH reached a maximum of 30 µg/L.

Correspondingly, the sludge generated in circulation mode contained high levels of sulphur (max. 79 g/kg dw), THC (max. 111 g/kg dw), vanadium (max. 12 g/kg dw), nickel (max. 5.4 g/kg dw) and copper (max. 1.1 g/kg dw). Also the content of PAH was significant (230 mg/kg dw), while dioxins/furans occurred in a relatively low concentration (26 ng/kg dw expressed in international toxicity equivalents (compared to Seveso dioxin; 2,3,7,8-TCDD)) and PCBs were not detected at all (detection limit 1 µg/kg dw per congener).

Due to the contents of nickel, vanadium and THC the sludge is classified hazardous waste and must be treated and disposed of accordingly when transported to land. Facilities suitable for reception, handling, transport, treatment and disposal of scrubber sludge generally exist or can be made easily available in Danish ports and downstream installations/facilities.

For the assessment of possible impacts of discharges of scrubber water on the marine environment modeling of the dispersion was carried out using the Kattegat Sea and the Aarhus Bight as model areas representing an open sea area with high traffic intensity and a more confined and shallow, coastal area with significant ship traffic, respectively. Further, detailed AIS-data on the actual ship traffic in the two areas from mid 2008 to mid 2009 were used in combination with assumptions on average engine size for the different categories and sizes of the ships. With regard to the level of pollutants in the scrubber water, the results from Ficara Seaways were used with the exception of sulphur for which a worst-case approach was applied assuming all ships to use fuel with 3.5 % S (present IMO cap), and 100 % trapping and discharge to the sea.

These basic conditions were applied to a number of scenarios; an "all ships" scenario in which all ships use scrubbers for exhaust gas cleaning, a "one ship" scenario addressing the possible local, short-term impacts of one ship discharging scrubber water, a "no scrubbers" scenario where all ships use 0.1 % S fuel instead of scrubbers, and a "scrubbers in port" scenario assessing the scrubbing of exhaust from auxiliary engines used by ships while in port.

The resulting pollutant concentrations in the two study areas were compared to the current environmental quality standards (EQS) for marine waters in force in the EU, and a few more stringent values applicable to Danish territorial waters. Sulphuric acid was compared to the buffering capacity of sea water.

Overall, the concentrations were far below the levels of concern as already described under main conclusions. In ports, the levels may, depending on the local conditions, come close to or even slightly exceed the EQS's.

Dansk sammendrag

For at nedsætte luftforureningen fra skibe er det vedtaget at reducere det tilladelige indhold af svovl i fuelolie. Et alternativ til denne løsning kunne være at rense skibenes udstødningsgasser ved hjælp af såkaldte scrubbere, men de mulige konsekvenser for havmiljøet af denne løsning er ikke tidligere blevet vurderet detaljeret. I dette projekt vurderes en række generelle problemstillinger relateret til udledninger fra scrubbere til havmiljøet, og det konkluderes, at i forhold til gældende miljøkvalitetsstandarder vil udledningerne af stoffer med vaskevand for alle de undersøgte parametre være betydeligt under de niveauer, hvor der kan være risiko for biologiske effekter i havmiljøet. Ved en risikovurdering for en konkret geografisk område skal også det aktuelle lokale forureningsniveau samt tilførsler af stoffer fra andre kilder tages i betragtning.

Baggrund og formål

Som et svar på den stigende bekymring og opmærksomhed på luftforurening fra skibstrafik har det internationale samfund gennem MARPOL-konventionen siden 1997 iværksat en række initiativer, ikke mindst for at reducere emissionerne af svovl og partikler. Således er der sat grænser for indholdet af svovl i fuelolie til skibe (3,5 % fra januar 2012) og begrebet "Emission Control Area" (ECA) er introduceret og indebærer, at der i særligt følsomme havområder, som f.eks. Østersøområdet, gælder endnu strengere miljørelaterede bestemmelser for skibstrafikken (for tiden max. 1 % svovl).

I 2015 vil det tilladelige indhold af svovl i fuelolie i ECA-områder blive sat ned til 0,1 %, men der er nu bekymring for, at der ikke vil være nok olie tilgængeligt med dette lave svovlindhold til at opfylde behovet, når den nye begrænsning træder i kraft. MARPOL-konventionen åbner dog mulighed for, at brugen af scrubbere eller andre teknologiske løsninger kan tages i brug, såfremt de kan dokumenteres at have samme effekt og ikke medføre uacceptable påvirkninger.

For at imødegå bekymringen for, at en scrubberløsning måske blot vil konvertere et luftmiljøproblem til et havmiljøproblem, besluttede Miljøstyrelsen at iværksætte dette projekt, der gennem litteraturstudier og en praktisk undersøgelse skulle belyse og vurdere den mulige påvirkning af havmiljøet ved udledning af vaskevand fra scrubbere på skibe.

Undersøgelsen

Undersøgelsen er udført af COWI A/S i løbet af 2011 og har omfattet følgende hovedelementer:

- En litteraturbaseret gennemgang af principper og status for de vigtigste scrubbertyper til skibe med vægt på vådscrubbere til svovlfjernelse,
- en praktisk undersøgelse af forureningskomponenter i vaskevand og slam fra scrubbersystemet på Ficaria Seaways (en ro-ro carrier med 21 MW motor), der både kan drives med saltvand (gennemstrømning) og ferskvand (recirkulering),

- en vurdering af de mulige konsekvenser for havmiljøet (eksemplificeret ved Kattegat og Århusbugten) ved udledning af scrubbervand, hhv. hvis alle skibe forsynes med sådanne rensesystemer og hvis alle skibe bruger lav-svovl fuel i stedet for scrubber, samt af mulige lokale effekter af et enkelt skib og påvirkning ved brug af scrubber i havne, samt
- en vurdering af de eksisterende muligheder for at modtage, behandle og deponere slam fra scrubber på skibe.

Hovedkonklusioner

Ud fra oplysningerne i litteraturen vurderes det, at vådscribbere til skibe effektivt kan fjerne svovl fra udstødningsskibet og også hovedparten af sod og andre partikler. I scribberen omdannes den gasformige svovl til svovlsyre. En række andre forureningskomponenter så som metaller og PAH fjernes fra udstødningen med mere varierende effektivitet.

Vådscribberer på Ficara Seaways, der blev benyttet til den praktiske del af undersøgelsen, vurderes at være passende repræsentativ for den type scribbere og den gennemsnitlige skibsstørrelse, der er relevant for ECA-området, der dækker Østersøen og Nordsøen, og den er dermed egnet som grundlag for den efterfølgende vurdering af de mulige påvirkninger af havmiljøet i dette område.

Tilsvarende vurderes de to udvalgte delområder, Kattegat og Århus Bugt, at være repræsentative for hhv. et stærkt trafikeret åbent havområde og et mere afgrænset og relativt lavvandet kystnært område med en del skibstrafik. I hovedscenariet for konsekvenser for havmiljøet antages alle skibe > 2000 tons dødvægt at være forsynet med scribbere og at bruge fuelolie med højt svovlindhold (3,5 %). De udførte beregninger viser, at i dette scenarie vil indvirkningen fra udledningerne af vaskevand på pH og havvandets bufferkapacitet være helt ubetydelig i både Kattegat og Århusbugten. Dette vil også gælde selv om man øger skibstrafikken til det dobbelte eller antager den lavest mulige bufferkapacitet i ECA-området, som forekommer i den Botniske Bugt.

Specifikke miljøbelastende stoffer som tungmetaller, PAH'er, oliekomponenter og PCB vil også blive tilført havmiljøet med scrubbervandet. Imidlertid vil de resulterende koncentrationer være størrelsesordener under de gældende miljøkvalitetskrav (MKK) for det marine miljø i både EU og Danmark. Således vil koncentrationerne af de to mest kritiske stoffer i den sammenhæng, kobber og nikkel, stadig være mindst to størrelsesordener under MKK-værdien.

Det skal nævnes, at den udførte vurdering er en generisk miljøvurdering baseret på de principper og acceptkriterier, som benyttes af EU ved vurdering af kemiske stoffers påvirkninger af akvatiske miljøer. Den giver således en overordnet vurdering af scribbere som teknologi i forhold til havmiljøet. Derimod omfatter vurderingen ikke særlige problematikker og regler relateret til specifikke geografiske områder så som Natura 2000-områder o.lign., konsekvenser i forhold til miljømålsætninger af mere politisk karakter eller effekter af kumulative påvirkninger fra andre forureningskilder.

Et andet hovedscenarie, hvor mulige lokale effekter af scrubbervand fra et enkelt større skib vurderes, er baseret på resultaterne af undersøgelsen på

Ficaria Seaways (21 MW motor). Konklusionen for dette scenarie er, at udledningen af svovlsyre er uden betydning for pH og havets bufferkapacitet selv i mere lukkede farvande, samt at koncentrationerne af miljøfarlige stoffer vil ligge langt fra niveauer, der indebærer risiko for skader på organismer i havmiljøet.

I det tredje hovedscenarie, hvor alle skibe antages at benytte fuelolie med lavt svovlindhold (0,1 %) i stedet for scrubbere, viser naturligvis, at svovlemissionerne er helt negligerbare, men også at metaller som nikkel og vanadium, der forekommer i olien proportionalt med svovlindholdet, vil emitteres i mindre mængder. Derimod vil en række andre metaller, oliekomponenter og PAH blive emitteret i samme grad, men fordelt mere ligeligt ud over området.

Brugen af scrubbere i havne til rensning af udstødning fra hjælpemotorer og af udstødning hidrørende fra produktion af inert gas på tankskibe ved losning, vurderes i det lange løb under nogle forhold at kunne medføre koncentrationer i havne vandet, der ligger tæt på eller måske endda over MKK-værdierne.

Hvad angår det slam, der produceres af scrubbere, der fungerer med recirkuleret ferskvand, konkluderes det, at der allerede eksisterer faciliteter i Danmark til modtagelse, transport, behandling og deponering af sådant slam.

Projekresultater

Der findes tre hovedtyper af vådscrubere:

- SO_x -scrubere, der især skal fange svovloxider, men også partikler mv. (to undertyper: flow-through (saltvand) og cirkulation (ferskvand)),
- EGR-scrubere (Exhaust Gas Re-circulation), som især skal reducere NO_x , men som også reducerer SO_x og partikler, samt
- inert gas-scrubere, der egentlig blot er små SO_x -scrubere, der bruges på tankskibe ved fremstilling af inert gas i forbindelse med tømning af tankene.

Der findes et antal producenter af sådanne vådscrubere, men området må stadig siges at være på et forholdsvis tidligt stadie af kommercialisering i modsætning til meget beslægtede systemer, der har været anvendt af landbaserede industrier gennem mere end 30 år.

De gasformige svovlforbindelser, SO_x , opfanges med mere end 90 %'s effektivitet i scrubere, hvor de hurtigt omdannes til svovlsyrling og videre til svovlsyre. Syren neutraliseres ved udledning til havet af de buffersystemer, der findes der, primært bicarbonatsystemet. I cirkulationssystemer med ferskvand tilsættes typisk natriumhydroxid for at neutralisere vaskevandet for at undgå korrosion af tanke og rør. Partikler opfanges med betydeligt lavere og mere varierende effektivitet.

De saltvandsbaserede flow-through-systemer udleder vaskevandet direkte til havet, for de flestes vedkommende uden nogen forudgående behandling eller rensning af vaskevandet. I modsætning til dette fjernes partikler normalt fra de ferskvandsbaserede cirkulationssystemer, typisk ved centrifugering, hvilket

giver anledning til en produktion af slam, der opsamles og bringes i land mhp. videre behandling og deponering.

De praktiske undersøgelser af vaskevand og slam fra scrubberne foregik på Ficara Seaways, som er en 230 meter lang, 14500 tons tung ro-ro carrier med en 21 MW to-takts motor, som anses for at være rimeligt repræsentativ for et gennemsnitligt skib i Østersø-/Nordsøområdet både mht. størrelse og scrubbertype. Skibet er forsynet med et dobbelt scrubbersystem, der kan fungere både med saltvand (SW; flow-through) og med ferskvand (FW; cirkulation).

Prøvetagning blev foretaget både under saltvands- og ferskvandsbaseret drift og med to fuelolier med hhv. 2,2 % svovl og 1,0 % svovl. Ved begge driftsformer blev der taget prøver når hovedmotoren arbejdede ved 85-90 % af maks. kapacitet, og saltvandsbaserede prøver blev yderligere taget ved den halve belastningsgrad af motoren (40-45 %). Der blev taget slamprøver under ferskvandsbaseret drift og desuden blev der taget referenceprøver af både saltvand og ferskvand samt prøver af de anvendte fuelolier.

Vandprøverne blev analyseret kemisk for følgende parametre og stoffer: pH, total-N, total-S, COD, suspenderet stof, otte metaller (arsen, bly, cadmium, kobber, kviksølv, nikkel, vanadium og zink), oliehydrocarboner (THC) og polycykliske hydrocarboner (PAH; 16 udvalgte jf. USEPA). Analyseprogrammet for slam omfattede desuden PCB og polychloreerede dioxiner/furaner (PCDD/F). Fuelolie blev kun analyseret for metaller og svovl.

Med hensyn fuelolie viste analyserne, at niveauet af de fleste metaller lå under detektionsgrænsen og kun indholdene af nikkel og vanadium var så høje, at de kunne kvantificeres (sammen med svovl).

Nikkel og vanadium blev også betydeligt forøget i vaskevandet fra scrubberne ved flow-through (saltvand) sammenlignet med referenceprøverne, men koncentrationerne af kobber (op til 260 µg/l) og zink (op til 450 µg/l) var endnu højere. Disse to metaller blev ikke påvist i fuelolien og årsagen til deres forekomst i vaskevandet er ikke blevet fundet, men skyldes muligvis kontaminering fra den aftapningshane, der blev benyttet ved prøvetagningen. Desuden kunne der måles et højere indhold af svovl i vaskevandet på trods af det høje naturlige niveau af svovl i havvand, og pH var også tydeligt påvirket (mest ved den mest svovlholdige olie). Niveauerne af PAH og THC var derimod lave (summen af PAH var kun lige over 1 µg/l som maksimum, mens max. for THC var 330 µg/l).

Ved ferskvandsbaseret drift med cirkulation blev akkumuleringen af forurening over tid undersøgt ved prøvetagning hvert 20. minut gennem 2 timer og efterfølgende analyse af prøvernes indhold af suspenderet stof. Opbygningen af stof i vaskevandet var stort set lineær ift. tiden, og den nåede ikke et mætningspunkt inden for undersøgelsesperioden. De fleste stoffer og parametre blev opkoncentreret i betydelig grad i løbet af 2 timers perioden, mens startkoncentrationen af enkelte stoffer var så høj pga. rester af vaskevand i tanken fra foregående renseperiode, at en mulig koncentrationsudvikling ikke kunne afgøres. Særligt høje niveauer efter 2 timers drift blev fundet for svovl (max. 6400 mg/l), vanadium (max. 17.000 µg/l), nikkel (max. 4500 µg/l) og THC (29.000 µg/l). Summen af PAH-forbindelser nåede et maksimum på 30 µg/l.

I overensstemmelse med disse observationer blev det også fundet, at slammet produceret ved efterfølgende centrifugering af vaskevandet havde høje indhold af svovl (max. 79 g/kg ts), THC (max. 11 g/kg ts), vanadium (max. 12 g/kg ts), nikkel (max. 5,4 g/kg ts) og kobber (max. 1,1 g/kg ts). PAH-indholdet var også signifikant (op til 330 mg/kg ts), mens dioxiner/furaner kun forekom i relativt lave koncentrationer (max. 26 ng/kg ts udtrykt i toksicitetsækvivalenter ift. Seveso-dioxin (2,3,7,8-TCDD)) og PCB slet ikke kunne påvises med en detektionsgrænse på 1 µg/kg ts.

På grund af indholdene af nikkel, vanadium og THC klassificeres scrubberslammet som farligt affald og skal opbevares og behandles i overensstemmelse hermed. Det vurderes, at der allerede findes faciliteter og systemer i Danmark, der er egnede til modtagelse, transport, behandling og deponering af sådant slam.

Vurderingen af de mulige konsekvenser for det marine miljø af udledning af scrubbervand fra skibe er foretaget ved spredningsberegninger med hhv. Kattegat og Århus Bugt som repræsentanter for hhv. et åbent, stærkt trafikeret havområde og et mere lukket, relativt lavvandet område med betydelig skibstrafik. Detaljerede AIS-data over et år (2008 til 2009) er benyttet til at fastlægge omfanget og sammensætningen af skibstrafikken i de to områder, og der er foretaget en vurdering af typiske motorstørrelser og -belastninger for de forskellige typer og størrelseskategorier af skibene. Med hensyn til forureningsniveauet i scrubbervandet er dataene fra Ficara Seaways benyttet som grundlag hvad angår de miljøfarlige stoffer, mens der for svovl er foretaget en teoretisk worst-case beregning baseret på olie med 3,5 % svovlindhold (max. værdi tilladt af IMO) samt 100 % opfangning og udledning af svovlet til havet.

Disse basisbetingelser blev knyttet til tre forskellige hovedscenarier; et "alle skibe"-scenarie, hvor alle skibe > 2000 tons dwt benytter scrubbere til rensning af udstødningsgasser, et "et skib"-scenarie, som vurderer den mulige lokale påvirkning fra et enkelt, større skib med scrubber samt et "ingen scrubbere"-scenarie, hvori alle skibe antages at sejle på fuelolie med 0,1 % svovl i stedet for at rense udstødningsgassen. Desuden er der lavet en vurdering af betydningen af anvendelse af scrubbere på skibe i havn.

Selve vurderingen er foregået ved at sammenligne de beregnede koncentrationer af de forskellige forureningskomponenter med de tilhørende miljøkvalitetskrav (MKK) gældende for havmiljøet i Nordsø-/Østersøområdet samt nogle strengere krav for enkelte stoffer gældende i danske farvande. Udledningen af svovlsyre er dog vurderet i forhold til havområdernes naturlige bufferkapacitet over for forsurening.

Som allerede beskrevet under "hovedkonklusioner" var de beregnede koncentrationer langt under de gældende MKK-værdier, for svovls vedkommende langt under bufferkapaciteten i havet. Dog vurderes det, at der ved brug af scrubbere i trafikerede havne under visse omstændigheder og for nogle stoffer vil kunne forekomme koncentrationer lige omkring kravværdien.

1 Introduction

In response to growing concerns about air pollution from ship traffic and its environmental consequences, the international society has through MARPOL gradually introduced initiatives and measures addressing this issue, not least with regard to reduction of air emissions of sulphur dioxide and particulate matter.

Thus, a Protocol was adopted in 1997 which put a cap on sulphur content in marine fuels of 4.5 % and introduced the concept of SO_x Emission Control Areas (SECA) limiting the content of sulphur in marine fuels to 1.5 % in particularly sensitive areas. Originally, only the Baltic Sea was designated SECA in the Protocol, while the North Sea and English Channel SECA was adopted in July 2007.

Later, the concept of SECA is redefined ECA (Emission Control Area) which opens for regulating other air emission parameters, e.g. NO_x, in the designated areas. ECAs are becoming more widespread and today large portions of US, Canadian waters are about to be designated ECA. IMO works with the aim of implementation by August 2012.

In 2012 the limit for sulphur in marine fuels will be lowered to 3.5 % sulphur (S) and in 2020 to 0.5 % S. In ECA the original limit of 1.5 % S is presently 1.0 % and will be lowered to 0.1 % S already in 2015. At present there appears to be a significant risk that the demand for low sulphur marine fuels will not be possible to meet when the new restrictions enter into force.

However, as an alternative to the use of low sulphur fuel, Regulation 14 of Marpol Annex VI allows for the use of exhaust gas cleaning systems or any other technological method to limit SO_x emissions to give a similar effect as low sulphur fuel.

To explore this option, and in the light of the mentioned risk of severe shortage of low sulphur HFO, the Danish EPA decided in 2008 to support and co-finance the development of a wet scrubber system for large vessels, which can operate both in a flow-through mode using sea water and in a re-circulation mode using fresh water.

To address the concern that the use of scrubber systems to reduce SO₂ and other air emissions from ships could possibly merely transform an air pollution problem into a marine environmental problem, the Danish EPA further decided to initiate the current study giving an assessment of the issue based on a literature study and practical investigations of a selected wet scrubber system.

1.1 Objectives

The specific objectives of the study and assessments reported here are:

- To provide an overview and environmental assessment of existing exhaust gas scrubber systems for ships based on available literature and other information sources.
- Characterise and assess the emissions of scrubber water and sludge from a selected ship scrubber system through a practical investigation
- Assess the possible impacts of scrubber water discharges on the marine environment
- Describe and assess options for treatment and disposal of scrubber sludge.

1.2 Project organisation

The project was carried out in 2011 by a project team in COWI A/S with Jesper Kjølholt as project manager and Stian Aakre, Carsten Jürgensen and Jørn Lauridsen as the other team members.

The project responsible in the Danish EPA was Flemming Bak.

A steering group was formed with the following members:

- Flemming Bak, Danish EPA (chairman)
- Mariane Hounum, Danish EPA
- Carsten Bøgsted Mathiesen, Danish EPA
- Torben Wallach, Danish Nature Agency
- Palle Kristensen, Danish Maritime Agency
- Clea Henriksen, Danish Maritime Agency
- Nete Herskind, Danish Ports Association.

The project is financed under the Danish Action Plan for Ecoinnovation 2010-2011.

1.3 Project activities

The project has comprised the following main components:

- Literature study and collection of information from other sources
- Sampling and analysis of scrubber wash water effluent and sludge from the wet scrubber on board the ro-ro vessel Ficaria Seaways

Impact assessment of the discharges to the marine environment and of the sludge produced

2 Legislative framework

The International Convention for the Prevention of Pollution from Ships, now known universally as MARPOL was adopted by IMO (International Maritime Organization) in 1973. Air emissions from ships are first and foremost regulated through MARPOL amendment protocol of 1997 where Annex VI was added and named Regulations for the Prevention of Air Pollution from Ships.

The Annex VI entered into force in 2005 and introduced the notion SECA (SO_x Emission Control Area). The first SECA to be fully implemented was the Baltic Sea in 2006 and the corresponding regulation stated a 1.5% limit on fuel sulphur content within the area. In 2007, the North Sea and the English Channel was adopted as the second SECA.

Opening the door for abatement technologies as exhaust gas cleaning systems is the fact that Annex VI allows alternative means of emission reduction i.e. approved technical solutions. For the SECAs at that time the equivalent of 1.5% sulphur limit in fuel was announced to be 6 g SO_x/kWh. The revised Annex VI from 2008 redefines SECA to ECA (Emission Control Areas) and thereby opens for restrictions on other air emission parameters as particulate matter and NO_x.

Sulphur limits in fuel inside ECAs are currently 1.0% and will be reduced to 0.1% in January 2015. Outside ECAs, sulphur limits are currently 4.5%, being reduced to 3.5% in 2012 and further to 0.5% in 2020 or 2025. The latter deadline will only be relevant, if an availability study in 2018 shows that sufficient low sulphur fuel is not expected to be available by 2020.

Annex VI no longer states a definite sulphur emission limit using alternative abatement technologies, but still allows such alternatives. The current regulation states that alternatives should be "at least as effective in terms of emissions reduction as that required by the Annex".

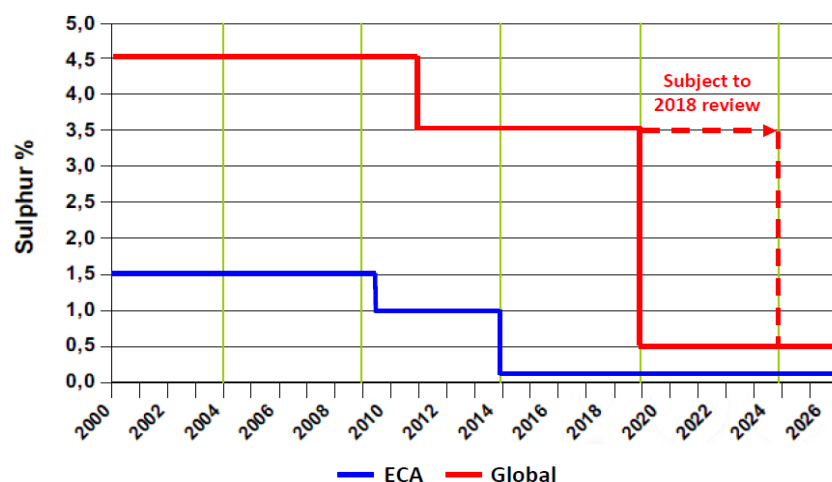

Figure 2-1 IMO timeline and limits for sulphur content in fuel (Courtesy Gregory et al. 2010)

Alternative emission reduction technologies apart from LNG (Liquefied Natural Gas) are for all practical reasons exhaust gas cleaning systems, which are subject to a set of IMO Guidelines for Exhaust Gas Cleaning Systems in order to document efficiency at least as good as the requirements in Annex VI. The previous requirement of SO_x-emission limit of 6 g SO_x/kWh is now replaced by measurement of SO₂ (ppm)/CO₂(%) ratio after the cleaning unit.

This parameter has shown a robust co-variation with fuel oil sulphur content. As most exhaust gas cleaning systems are wet scrubbers, particular attention is being paid to the composition of wash water effluent. The third Guidelines for Exhaust Gas Cleaning Systems (MEPC Resolution 184/59, 2009) entered into force July 2010 and require monitoring and logging of the following wash water parameters: pH, PAH (polycyclic aromatic hydrocarbons) and turbidity.

Annex 9 to MEPC 184/59 establishes a number of specific criteria to discharge of washwater from exhaust gas scrubbers (EGC):

- pH of no less than 6.5¹
- concentration of PAH (phenanthrene equivalents) max. 50 µg/L
- turbidity not more than 25 FNU or 25 NTU above inlet turbidity
- nitrates not higher than that associated with 12 % NO_x removal or 60 mg/L for wash water discharge rate of 45 tons/MWh, whichever is greater.

IMO recognises the need for further information on wash water composition before final regulations can be adopted; this report aiming to contribute to this.

In 2009, USA and Canada submitted a proposition to define coastal waters extending 200 nautical miles from the east and west coasts and around Hawaii as ECA. The proposition was adopted in 2010. It includes requirements for particulate matter and NO_x in addition to SO_x and will enter into force August 2012.

ECA submittals for Korea, Japan and Singapore are also reported to be under preparation.

Regional emission control

European Council Directive 2005/33 requires all vessels in a European Union member state port, at berth or at anchor to use 0.1% sulphur fuel. (A few exemptions are given). Also, during regular service between member state ports and in European Union waters, passenger vessels must use 1.5% sulphur fuel.

The directive allows for abatement technology as a substitute for low sulphur fuel, either as trial runs approved by EU member states or systems approved according to IMO guidelines.

The California Air Resources Board requires that distillate fuels are used within 24 nautical miles of the Californian coast - unless on "continuous and expeditious navigation". The sulphur limits are through 2011 1.5% for marine gas oil (MGO) and 1.0% for marine diesel oil (MDO). From 2012 the limit

¹ It is believed that this pH requirement is meant to address discharges occurring in ports and therefore unintentionally appears among the requirements to discharges at open sea. IMO is anticipated to correct this in connection with the next revision of the document.

will be 0.1% for both. It is stated that the regional requirements in California will cease upon North American ECA commencement date.

Finally, different regional programmes are established. These include HELCOM for the Baltic Sea, OSPAR for the North East Atlantic and others under the UNEP Regional Seas Programme. These programmes are working to support global regulations rather than developing their own regional regimes. E.g. HELCOM puts it this way on www.helcom.fi:

Due to the international character of shipping the measures adopted at HELCOM scale will only have limited impact on the emissions from shipping in the Baltic. Therefore, HELCOM is first of all taking active part in the global actions within the International Maritime Organization (IMO) to reduce air pollution from ships. The call for stricter IMO requirements is part of the HELCOM Baltic Sea Action Plan to drastically reduce pollution to the sea and restore its good ecological status by 2021.

As this report focuses on scrubber technology and hence SO_x removal, regulations concerning other air emission parameters like NO_x are not discussed further.

3 Overview of scrubber systems on ships

3.1 Description of existing systems

As a background to this chapter a literature study has been carried out. A description of relevant scrubber categories is given along with a compilation of their discharges, emissions and wastes. Furthermore, some thoughts are given on future development of marine use of scrubbers and finally a comparative assessment sums up properties, benefits and challenges.

Once limited to the category "scrubber systems", these exhaust gas cleaning systems can be broadly divided into two types: wet and dry. Wet scrubber systems use seawater or freshwater in combination with chemical additives such as NaOH - or the scrubber may be able to operate in both modes.

For marine use, wet scrubbers are so far dominating the market. As of beginning of 2011, only one vendor is known to commercially offer dry scrubbers.

The main purpose for both wet and dry scrubbers is to remove sulphur oxides from exhaust streams. A positive, additional effect is the trapping of particulate matter in the exhaust reducing airside emissions of heavy metals, soot, PAH's and also sulphur bonded to the particles.

In the following sections, three categories of wet scrubbers in addition to dry scrubbers are discussed. The three categories of wet scrubbers are de facto three utilisation methods of the same scrubber principle:

- Scrubbers used to remove SO_x and particulate matter from marine engine exhaust.
- EGR (exhaust gas re-circulation) scrubbers used to remove SO_x and particulate matter from re-circulated exhaust gas to prevent fouling and corrosion of engine components. The EGR itself being aimed at reducing NO_x from the engine exhaust.
- Inert gas (flue gas) scrubbers used to remove SO_x and particulate matter from gas being used as inert substitution in tanks and pipelines onboard ships.

Chemistry of SO₂ removal

For all the wet scrubbers, the basic chemistry is similar and can be described along the following principles:



The sulphurous acid will ionise in water with normal acidity creating bisulphite and sulphite ions:

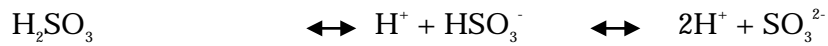

In seawater containing oxygen the sulphite will readily oxidise to sulphate:
 $\text{SO}_3^{2-} + 1/2\text{O}_2 \quad \rightarrow \quad \text{SO}_4^{2-}$

Also the sulphuric acid deriving from the exhaust SO_3 fraction will undergo similar reactions, creating sulphate and surplus acidity (H^+ ions):

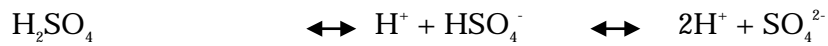

The acidity resulting from these reactions in the scrubbing process is mainly neutralised by the natural buffering capacity in the seawater, given sufficient amounts of water. The buffering capacity in seawater is significantly caused by the content of natural bicarbonate (HCO_3^-) content.

The basic chemistry of wet scrubbers using re-circulated fresh water is similar, but lack of natural buffering capacity in the water must be compensated by introducing a suitable alkaline chemical. Most available systems utilise NaOH (sodium hydroxide/caustic soda) for this purpose. Sodium hydroxide is found as ions in aqueous solution:

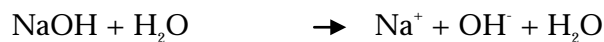

Similar to seawater scrubbing, the fresh water scrubbing will (depending on pH) ionise and oxidise SO_2 and SO_3 from the exhaust gas into sulphate and surplus acidity (H^+ ions). Having sodium present the sulphate, bisulphite and sulphite will form a mixture of sodium sulphate, sodium bisulphite and sodium sulphite:



The hydroxide ions will neutralise the surplus acidity:



For the basic chemistry of dry scrubbers, see chapter 4.1.4.

3.1.1 SO_x scrubbers

The SO_x scrubber is the main topic of interest in this study and is an installation cleaning the exhaust from the main engine. The scrubber installation consists basically of the scrubber unit itself mounted on the exhaust outlet from the engine, followed in most cases by a wash water treatment and finally wash water discharge.

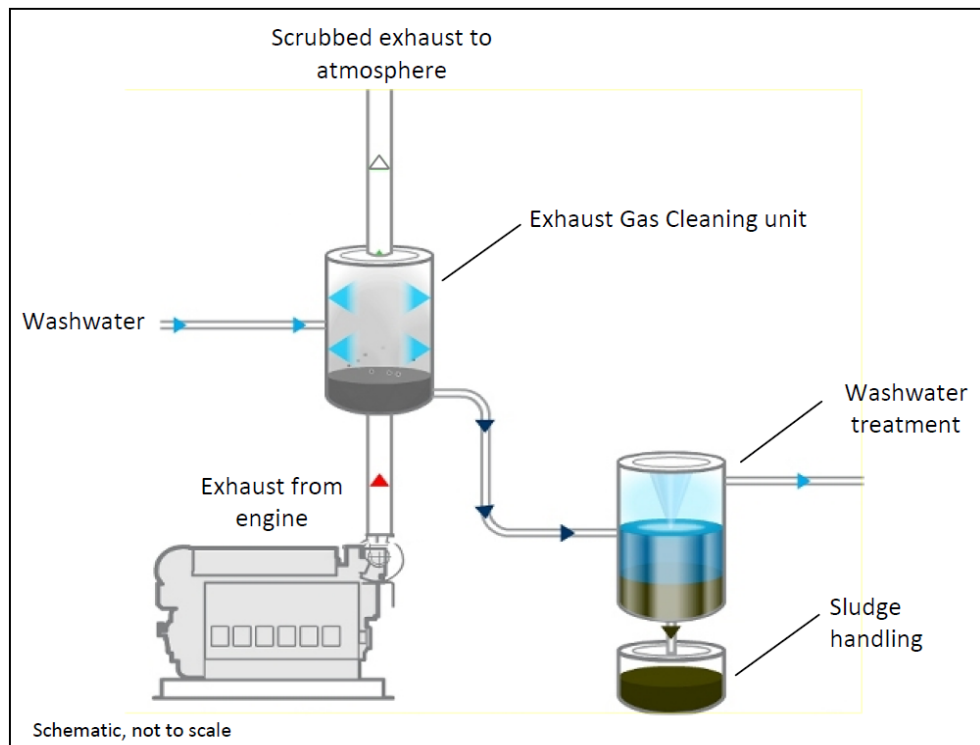

Figure 3-1 Open loop seawater scrubber (Courtesy Gregory et al. 2010)

Figure 3-1 describes an open loop seawater scrubber system where the washing water only passes through the system once before (in some cases, cleaning) and discharge. The principle of closed loop exhaust gas cleaning system is shown in Figure 3-2.

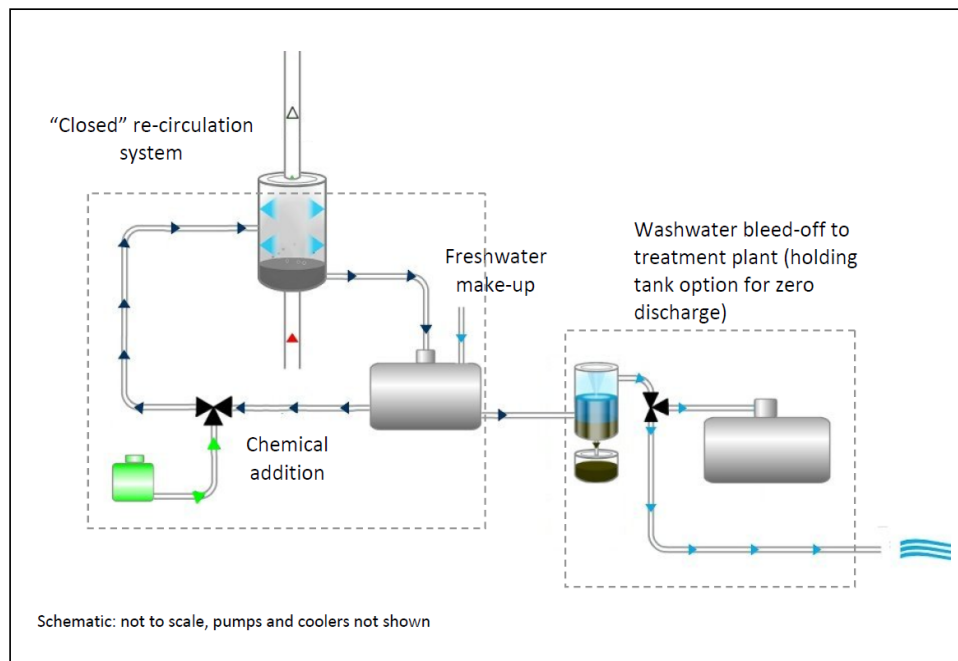

Figure 3-2 Closed loop scrubber (Courtesy Gregory et al. 2010)

Working principle

The basic chemistry for wet scrubbers removing SO_x is described above in section 3.1. The scrubber itself is a chamber of brand specific design, all

aimed at maximising intimate contact between the exhaust gas stream and the washing water. Different vendors have through testing and parallels from on shore scrubber applications developed what they believe is the most efficient technical approach to solve the scrubbing task.

According to Gregory et al. (2010) who gathered system information and performance data from seven wet scrubber vendors, three systems are able to switch between open loop using seawater and re-circulation mode using fresh water and chemical additives. (At least one of these systems is using a small, constant sodium hydroxide addition also in open seawater mode to prevent excessive equipment corrosion.) Two suppliers are using solely closed loop solutions and two use only seawater for the scrubbing process.

Detailed information of the scrubber reactor itself is not readily available for the available systems, but apparently it varies from leading the exhaust gas through a concentric duct into a shallow water tank to cyclone designs on the scrubbing unit.

Whereas the sulphur removal rate seems to be relatively similar in different available marine wet scrubbers (see below), particulate matter capture seems to vary more between the scrubber reactor designs. This fact has led some vendors to test means of pre-treatment of the exhaust gas (Gregory et al. 2010). These efforts include jet nozzles and an adjustable venturi. More efficient for particulate matter capture, seems to be the venturi. In brief the venturi provides a flow constriction resulting in lower pressure and higher exhaust gas velocity. These factors combined will increase turbulence and enhance the removal efficiency. However, increased venturi constriction may lead to higher back pressure and thereby alter the difficult balance of keeping the scrubber efficiency optimised without compromising engine performance / fuel consumption.

Challenges in wet scrubber design in addition to maximum sulphur removal are (MEPC 56/INF.5/Annex 1 2007):

- Maintaining a buoyant exhaust (i.e. avoid excessive exhaust cooling during scrubbing)
- Maintaining minimum consumption of space, weight and energy
- Maintaining minimum pressure drop in the exhaust
- Preventing corrosion
- Preventing water droplets in exhaust

Cleaning performance

Basically, the sulphur reduction rates will depend on the water flow rate in the wet scrubber. To illustrate this, one testing regime show variations of 65% to 94% sulphur reduction (Ritchie et al. 2005). The only variable in these tests was the water flow which was restricted in the case of 65% efficiency and oversupplied in the case of 94% efficiency.

Manufacturers of wet exhaust gas scrubbers report from 90 - 99% sulphur removal rates given favourable operating conditions. More interesting is to study the cleaning performance of commercially available wet scrubbers by comparing the maximum % sulphur in fuel the systems are able to clean to air emissions equivalent of 0.1% sulphur in fuel. The cleaning performances indicated in the table below are based on information from vendors of SO_x cleaning equipment and are not in all cases verified by independent reports.

Table 3-1 SO_x cleaning performance sorted by scrubber operating mode. Indicates the maximum % sulphur in fuel the system is able to clean and achieve air emissions equivalent of 0.1% sulphur in fuel. (All numbers relates to standard commercial offers from vendors.)

Parameter	Modes	Cleaning performance (max % sulphur in fuel)	Comments
SO _x	Switchable	3 to no limit*	Three vendors.
	Seawater	3.5	Two vendors, both stating 3.5% as max limit.
	Freshwater	3.5 to >5	Two vendors.

* No limit requires oversize scrubber, free water flow rate and high chemical consumption.

Cleaning performances of particulate matter (PM), NO_x and CO₂, based on information from vendors, are listed in Table 3-2 below. There are indications from ongoing projects that the figures may be somewhat optimistic and that for e.g. risk assessment about 50% efficiency will be more appropriate to assume.

Table 3-2 Particulate matter (PM), NO_x and CO₂ cleaning performances sorted by scrubber operating mode. (All figures relate to standard commercial offers from vendors.)

Parameter	Modes	Cleaning performance (%)	Comments
PM	Switchable	60 to >90	Three vendors. The lowest removal rate of 60% can be improved by different process design but creating back pressure penalty. Removal rate in excess of 90% is also due to scaling of unit, water flow and chemical addition, ref SO _x cleaning in table 4-1
	Seawater	70 to 90	Two vendors. 90% removal rate is reported to be of visible PM (50% of mass).
	Freshwater	65 to 95	Two vendors
NO _x	Switchable	0 to "less than 10"	Three vendors. "Less than 10" is reported by vendor without ship trials, but with extensive shore based experience.
	Seawater	0 to 2.5	Two vendors
	Freshwater	7	Two vendors. One vendor delivers scrubbers combined with SCR and is not reporting NO _x removal solely for the scrubber.
CO ₂	Switchable	0 to 15	Three vendors. CO ₂ removal of up to 15% requires high NaOH dosage.
	Seawater	0	Two vendors
	Freshwater	0	Two vendors

Due to the scrubber ability to capture particulate matter, variable fractions of other emission parameters will be found in the wash water effluent. The amount and composition of particles generated by marine diesel engines are influenced by the combustion process and the type of fuel used. The composition of particles may be divided in three main groups (MEPC 56/INF.5/Annex 1 2007):

- Metal oxides and sulphates - derives mainly from the fuel used, but some contribution to these substances in the wash water effluent may come from lubricating oil or wear of the engine and scrubber unit itself. For seawater scrubbers the wash water itself may contain

harmful substances. This is not an additional pollution and the issue is not generally expected to be problematic. However, background levels must be considered when monitoring effluent concentrations.

- Carbon (soot) - considered as generally stable compounds. The smaller particles (<2.5µm) are considered to pose higher respiratory hazards when released to air. Studies (MEPC 56/INF.5/Annex 1 2007) show that carbonaceous soot is found mainly in intermediate and larger particles. However, the size distribution of particles captured in wet scrubbers needs further investigation (a Danish research project NAKIM (www.nakim.dk) is in progress and a Norwegian research project on these questions headed by MARINTEK is planned to commence second quarter of 2011).
- Other organic compounds - contains typically PAH and PAH-derivatives, aldehydes, alkanes and alkenes as well as some unburned fuel or incombustible elements in the fuel. Many PAHs and PAH-derivatives, especially nitro-PAHs, have been found to be potent mutagens and carcinogens. Hence the present requirement of PAH-monitoring in wash water effluent from marine wet scrubbers.

Theoretically, there is a potential in removing CO₂ with a wet scrubber which is operated with addition of NaOH. This is due to the following reaction:



However, the preferred chemical reaction in the scrubber is removal of sulphur (see section 3.1) and hence the need of vast amounts of NaOH needed to achieve CO₂ reductions. The production of NaOH itself also has a CO₂ footprint. NaOH is basically a by-product from chlorine production through electrolysis of seawater to produce chlorine (for PVC purposes). Depending on the CO₂ footprint of the power used for this process, CO₂ scrubbing with use of NaOH could prove unfavourable CO₂-wise.

Implementation and practical use

Considerations regarding implementation and practical use include commercial availability along with size demands and supply regimes. Economic considerations are given in a separate section below.

Several of the manufacturers of marine exhaust gas scrubbers have experience from similar onshore applications, typically flue gas desulphurisation on power plants and oil refineries. Others are entering this market from the inert gas scrubbing for marine industry.

It must be concluded that as of 2011, 20 years after the first trial installation, marine use of after-treatment scrubbers is still in an early stage of commercialisation. But thousands have for the last 30 years been running as inert gas scrubbers.

The first prototype exhaust gas seawater system for ship emission control was installed in 1991 on Color Line's passenger ferry Kronprins Harald. In 1993 a seawater scrubber was developed by Kvaerner/Norske Shell and installed on the Norske Shell tanker MT Fjordshell. Marine Energy Ltd. (MEL, presently Marine Exhaust Solutions MES) scrubbed a partial stream of the exhaust on the ice breaker Louis S. St.-Laurent in 1998 and in cooperation with MAN

B&W installed a prototype of the scrubber unit known as Eco-Silencer on the ro/pax ferry Leif Ericson (previously Stena Challenger) in 2001. (Ritchie et al. 2005).

In more recent years, several manufacturers of wet scrubbing systems have fitted exhaust gas cleaning systems on ships. These installations include: Aalborg Industries (now part of the Alfa-Laval group) onboard ro-ro vessel Ficaria Seaways (now Ficaria Seaways), Hamworthy Krystallon onboard ro-ro ferry Pride of Kent and cruise ship Zaandam, Clean Marine on board chemical tanker Baru and Wärtsila onboard the chemical tanker Suula.

One manufacturer, ACTI, is known to not offer fixed installation onboard ships but have their scrubber system mounted on a barge. In port, the barge can approach the vessel and capture funnel exhaust from boilers and auxiliary engines for scrubbing.

Practical implications of wet scrubber use on board a vessel will mainly be related to logistics of consumables, foremost caustic soda. Caustic soda is typically consumed at a rate of between 1 and approximately 15 litres/h per MW of engine power. The higher the consumption of NaOH, the higher the removal of sulphur. An illustrative (approximate) indication of this is given in Table 3-3 below (Høy-Petersen N. 2011).

Table 3-3 Additive NaOH consumption required to achieve corresponding sulphur reductions in air emissions compared to sulphur content in fuel.

% sulphur removed	NaOH consumption (litres of 50% solution/MWh)
2.9	11
2.4	8
1.4	4
0.9	1

Space demand

There seems to little restrictions on the engine size suited for installation or retrofit of wet exhaust gas scrubbers. Vendors indicate anything between 20 MW to unlimited for effect per scrubber (Gregory et al. 2010). One vendor can combine scrubber units in parallel to accommodate any engine size.

Both system weight and volume will be of particular importance on retrofits, whereas in new buildings the system can easily be fitted during planning. Installation should be made downstream any exhaust boiler or economiser. Also, some scrubbers may be able to replace the exhaust silencer, leaving extra space available. Most commonly the scrubber unit is installed inside or outside but adjacent to the existing funnel.

In order to be able to control the pollutants transferred to the wash water, some wet scrubber manufacturers choose to fit a wash water treatment plant. These vary in process technology from flocculation to cyclone cleaning. See section 3.2.1 for further description. The wash water treatment plant will vary in size according to engine size. However, at this stage of marine scrubber development known wash water treatment plants require 1.5 to 4.5 m² floor space, depending on technology and engine size.

The wash water treatment plant has two effluent fractions. One being cleaned water being discharged overboard or stored for periodic zero discharge and a sludge fraction which has to be stored and disposed of onshore. Hence, means of residue storage must be available.

For wet scrubbers using fresh water recirculation as primary or supplementary means of operation, a process tank must also be available. Indications are found that the process tank should be between 10 and 40 m³ depending on engine size. If the vessel is not equipped to produce fresh water, bunkering limitations may further increase the tank requirements, this time for additional fresh water. Also, for periodic zero emission mode a holding tank must be fitted in fresh water/closed loop systems.

The consumption of fresh water requires production of fresh water onboard the vessel, or bunkering on shore. The first affecting energy consumption and the latter affecting tank capacity. Preferred solution will depend on trade, space capacity etc.

The chemical addition will also need tank capacity where applicable. The tank capacity will largely depend on vessel routing, possibilities for bunkering and required sulphur removal. However, most vendors recommend tanks of 10 m³ and above for this purpose.

Economic considerations

Due to the above mentioned fact that the scrubber technology is not fully commercially mature capital expenditures for retrofits are not well documented. Also, these costs will depend largely on the size of the engine, fuel to be used (cleaning potential), retrofit feasibility (space, plumbing etc).

Indications found in this study show that a wet scrubber for 1 MW engine may cost about USD 1 million, whereas a scrubber for 20 MW engine may be from USD 3-5 million. Instead of presenting a price for turn-key solution, one manufacturer is indicating pay back period less than one year - given estimated price differences between heavy fuel oil and distillate fuels prevail. One vendor is indicating a higher price (Gregory et al. 2010), but this is the barge mounted system with integrated SCR for NO_x removal. It is believed this price includes the barge and gives a turn-key port based solution.

Further economic considerations include energy consumption. This will obviously largely depend on engine size and hence scrubber size, but several other variables are present and the numbers in Table 3-4 are solely indicative.

Table 3-4 Power consumption of wet scrubber systems sorted by scrubber operating mode.

System	Power consumption (kW/MW engine effect)	Comments
Switchable	10 to 23	Three vendors. The lowest power consumptions are indicated for fresh water mode, mostly due to reduced pumping requirements.
Seawater	10 to 30	Two vendors
Freshwater	6 to 110	Two vendors. 110 is reported by manufacturer of barge mounted scrubbers combined with SCR. It is believed that the energy consumption is reported for the barge as a whole.

Operating costs are due to the lack of commercial experience mentioned above not well documented as of 2011. But Gregory et al. (2010) have collected the following numbers on operating cost based on combustion of 2.7 % S residual fuel for 300 days/year.

Table 3-5 Wet scrubber operating costs sorted by scrubber operating mode. Numbers as reported from vendors.

System	Operating cost	Comments
Switchable	No information	
Seawater	3% of capital cost	Includes power consumption and maintenance.
Freshwater	5 USD/MWh	Includes power consumption, NaOH, flocculant, maintenance and supervision.
	~USD 0.5 million to ~USD 2.5 million	Barge mounted scrubber operated 24 hours/day 365 days/year.

The exhaust gas cleaning system itself and pumps, pipes, valves etc. are exposed to corrosive environment as especially the sea water in the process can corrode black steel and stainless steel of normal grades (e.g. SS316). Manufacturers handle this differently, some utilising nickel based alloys, titanium or non-metallic materials such as epoxy and composites.

Deterioration and replacement of parts will therefore add to the manufacturing material demand and add to the cost and energy/greenhouse gas footprint of the exhaust gas cleaning system. These details are not discussed further in this study.

One study (Ritchie et al. 2005) has attempted to determine the cost per ton of emissions reduced for SO₂ using abatement measures versus fuel switching. The three scenarios considered are:

- Sea water scrubbing
- Fuel switching from 2.7% sulphur residual oil down to 1.5% sulphur residual oil
- Fuel switching from 2.7% sulphur residual oil down to 0.5% sulphur residual oil

The following sulphur emission reduction efficiencies have been used for calculation purposes:

Sea water scrubbing:		-75%
Fuel switching	2.7% -> 1.5%:	-44%
Fuel switching	2.7% -> 0.5%:	-81%

The results are presented in Table 3-6 as a function of vessel size and scrubber installation as new build/retrofit respectively.

Table 3-6 Cost per ton of emissions reduced for SO₂ abatement measures versus fuel switching See footnote.²

Measure	Ship type	Small vessel (€/ton SO ₂)	Medium vessel (€/ton SO ₂)	Large vessel (€/ton SO ₂)
Sea water scrubbing	New	390	351	320
Sea water scrubbing	Retrofit	576	535	504
Fuel switching 2.7% -> 1.5%	New/ retrofit	2,053 (1,230)	2,050 (1,230)	2,045 (1,230)
Fuel switching 2.7% -> 0.5%	New/ retrofit	1,439 (1,690)	1,438 (1,690)	1,434 (1,690)

Further uncertainties are related to these calculations such as:

- Inherent variations in costs of retrofitting due to ship specific factors
- Level of maintenance of the equipment
- Operating modes and load factors of the ship
- Variations in sulphur contents of fuels.

All together the results of the study are assessed to have an approximate 35% uncertainty range compared to the best estimate cost effectiveness figures which are quoted.

Another study (Reynolds K. 2011) has investigated the cost advantage for exhaust gas cleaning systems versus fuel switching options and concludes that starting 2015, ships that burn at least 4,000 metric tons of fuel oil annually within an ECA should consider an exhaust gas cleaning system. The study further states that a key break point in fuel cost differentials is when sulphur limits become so low that they cannot be practically or cost-effectively achieved by removing sulphur from residual fuels. The study claims that limits of 0.5% sulphur or lower generally require high-cost distillate fuel oil or alternatives such as EGCS or natural gas.

The crucial part of any calculation of this cost advantage strongly depends upon predictions and assumptions of fuel oil prices and the gap between high and low sulphur options. Ship operators are encouraged to utilize their own fuel cost differential predictions as the analysis is very sensitive to fuel cost escalations.

3.1.2 EGR scrubbers (DeNO_x systems)

The EGR (Exhaust Gas Re-circulation) system aims at reducing NO_x emissions from the engine. The principle is to re-circulate exhaust gas and mix with fresh combustion air to lower the oxygen content and increase the heat capacity of the combustion gas mixture. This lowers the peak

² Considerable uncertainty is related to the cost penalty of low sulphur fuels. The results in Table 3-6 relate to the use of BeicipFranlab (2003) fuel price information, whilst figures in brackets represent the use of Concawe estimates.

combustion temperature thereby suppressing the primary foundation of NO_x , of which some in turn oxidises to NO_2 and combined is denoted NO_x . To prevent fouling and corrosion of engine components and the EGR system itself, a scrubber unit is fitted.

Working principle

For the EGR scrubber the same wet technologies as for the SO_x scrubber can be applied. The currently available solution (test stage) is a closed loop freshwater scrubber that works with the addition of sodium hydroxide to neutralise the acidity resulting from the sulphur oxides. In the wash water treatment plant adding the necessary caustic soda, also particulate matter is separated and stored for designated disposal.

The scrubber in the EGR system also contributes to lower the temperature of the re-circulated exhaust gas. The gas is subsequently further cooled and dried in a water mist catcher as indicated in Figure 3-3.

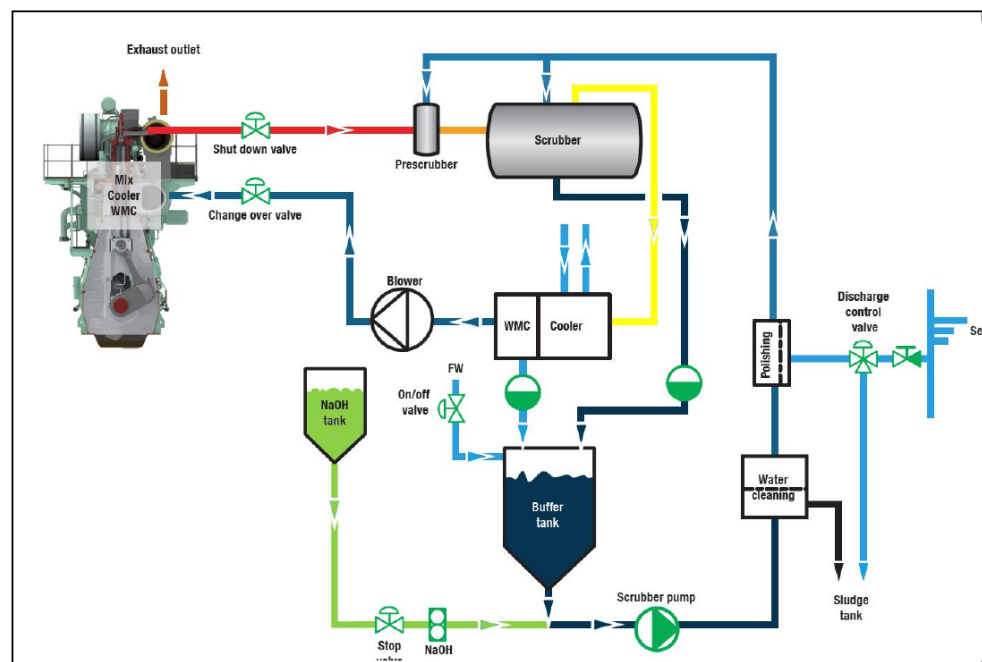

Figure 3-3 EGR system. Colour of gas flow indicates temperature. (Courtesy MAN Diesel & Turbo)

Being a well known principle in road transportation engines, EGR is a relatively new technology to the marine industry. There has been some successful trials on test engines and the first seagoing installations are also commissioned and being evaluated.

As the scrubber part of the EGR system is on the pressure side of the turbo charger. Working pressures up to 4 bar absolute and scrubber intake temperatures of 400°C must be expected. The higher pressure in combination with the fact that only a fraction of the exhaust is re-circulated (typically 20-40%) allows the EGR scrubber to be significantly smaller in physical size than the exhaust scrubber.

Cleaning performance

The main mission for the EGR system is to reduce NO_x emissions from the engine. During trials, NO_x reduction rates of more than 85% have been achieved but with an increase in specific fuel consumption and carbon

monoxide levels. (Gregory et al. 2010) Operation at low engine loads, which can be a problem for other NO_x reduction technologies such as SCR, also does not seem to pose a problem for EGR.

Being fitted with a SO_x scrubber to prevent engine fouling and corrosion, the EGR system also contributes to SO_x reduction from the engine exhaust. However, the scrubber is only removing sulphur from the fraction of exhaust being re-circulated. The overall contribution to SO_x reduction is therefore accordingly low. The typical recirculation rate will be between 20-40%.

Implementation and practical use

Although well known and proven technology in road transportation engines, EGR is new in marine use. Only one known test installation has been done, by MAN Diesel & Turbo on board container vessel Alexander Maersk. Space requirements for EGR will probably be reduced as the test installations develop into commercially available units. The preliminary estimates are at the time of writing 15-20 m³ for a 10 MW engine.

Economic considerations

The development stage of EGR technology leaves it too early to assess and conclude on the economics. One factor that will influence the development rate and probably the future pricing is whether EGR technology will succeed in being a Tier III solution for large, two-stroke diesel engines. So far, EGR is considered a promising candidate.

3.1.3 Inert gas cleaning scrubbers

Inert gas (or flue gas) cleaning scrubbers are designed to remove sulphur and particulate matter from gas being prepared to serve as inert gas substitution in tanks and pipelines of gas /liquid cargo being unloaded. The inert gas scrubbers are wet scrubbers similar in principle to the exhaust gas scrubbers but are smaller in size (gas handling volumes) and consume seawater at a much higher relative ratio than exhaust gas scrubbers. This is due to high gas cooling demand as maximum temperature on deck onboard tankers is 37°C. In most cases these are sea water scrubbers, but a technical option would be a re-circulating fresh water scrubber where sea water is additionally used for cooling purposes.

Working principle

The inert gas scrubber typically cleans the flue gas from an onboard boiler as the required maximum limit for O₂ in the inert gas is 8%. The boiler flue gas will normally contain 3-5% O₂, whereas the normal engine exhaust will have an O₂ level of 7-15% and hence not fulfil inert gas requirements. The system is primarily used on crude oil tankers and product tankers.

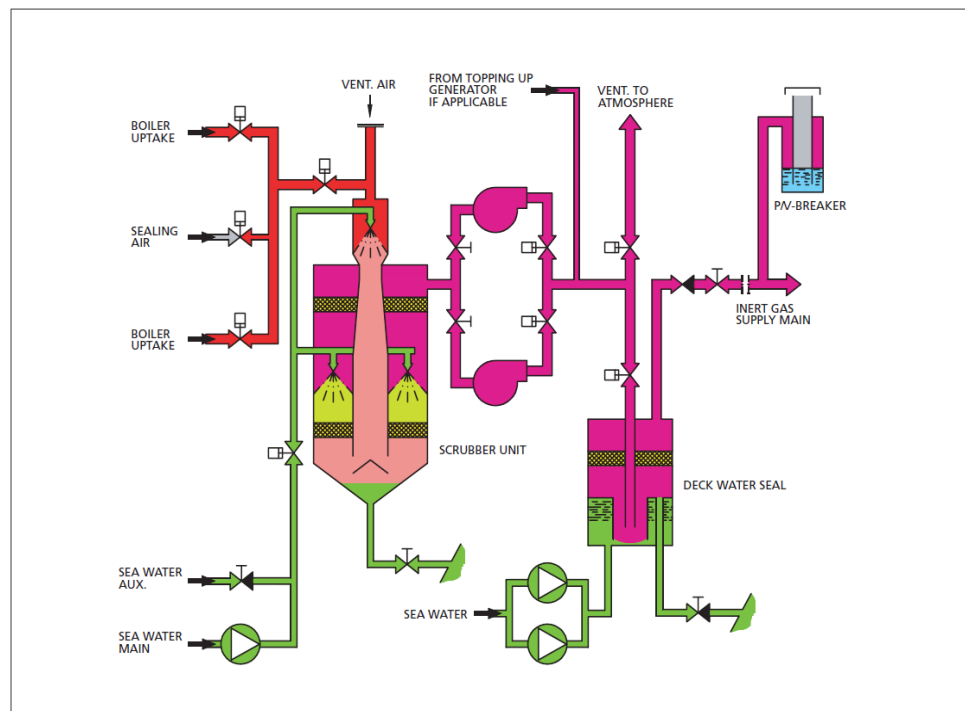

Figure 3-4 Inert gas scrubber/flue gas system (Courtesy Hamworthy)

Cleaning performance

Inert gas scrubbers are designed to deliver large amounts of sufficiently cooled inert gas (typical designs range from 2,000 up to 30,000 Nm³/h). When smaller amounts are needed, so called topping up inert gas generators are frequently used.

The scrubber part of the inert gas system has a high degree of sulphur removal and particulate matter capture due to the large amounts of water. The SO₂ content in the inert gas is normally less than 100 ppm, cleaned from a flue gas concentration of typically around 3,000 ppm, depending on the fuel used in the boiler.

Efficiency of soot extraction is reported (Hamworthy 2007) to equal or be higher than 99% of particles above 1 micron. O₂, CO₂, and NO_x are, similar to wet exhaust gas scrubbers, not significantly affected by the inert gas scrubbing process.

Implementation and practical use

Inert gas scrubbers as part of flue gas systems are widely recognised as an effective means of inerting cargo holds of crude oil tankers and product tankers, mainly where higher quality inert gas will not be required. (As the source is flue gas from the ship's boiler.)

Typical characteristics in practical use are the cooling requirements and hence the high sea water consumption which is known to be in the range of 0.010 - 0.020 m³/Nm³ gas.

Economic considerations

The purchasing and operating costs for inert gas systems are not discussed further in this report. However, power consumption of such systems is reported to be in the range of 0.01 kW/Nm³/h gas, somewhat depending on ship specific pumping requirements (Hamworthy 2007).

3.1.4 Dry scrubbers

Dry scrubbers are widely used for flue gas desulphurisation purposes on shore applications. The different dry scrubbers all rely on limestone or hydrated lime as cleaning agent.

Although a proven cleaning principle the disadvantages include supply and storage of lime products (scrubbing agents) along with storage and shore disposal of used reactant.

Dry scrubbing system available for marine use relies on a packed bed of hydrated lime (calcium hydroxide). Maximising the design of the scrubber unit and the delay of exhaust gas in contact with the granulate optimises the removal of both sulphur and particulate matter from the exhaust stream.

Chemical principles of dry scrubber reactions are as follows:

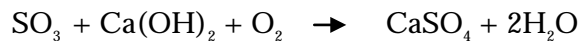
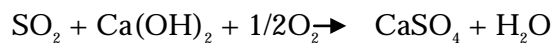

These reactions are exothermic, releasing heat, allowing the scrubber system to contribute to waste heat boiler efficiency with the correct installation.

Working principle

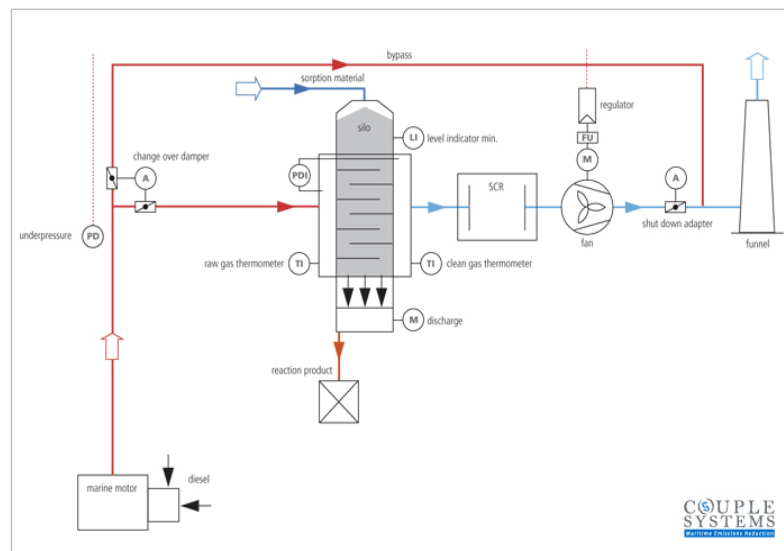

Figure 3-5 Dry scrubber system combined with SCR (Courtesy Couple Systems)

Cleaning performance

For SO_x removal trial operations with dry scrubbers has proved up to 99% (Couple Systems 2010). 4.5% sulphur in fuel is the maximum for achieving air emissions equivalent to 0.1% sulphur in fuel.

According to the manufacturer, the removal of particulate matter is about 80%. The packed bed and the porosity of the granulate works like a filter medium for soot particles. The particle capture is only assessed for the larger, soot based particles in the exhaust.

One advantage of the dry scrubber is the possibilities of integration with SCR (Selective Catalytic Reduction) NO_x removal. As the process in the dry scrubber packed bed releases heat, the exhaust stream leaves the scrubbing process with an ideal temperature for optimised SCR treatment. In this integrated system, the exhaust gas will be cleaned for SO_x upon entering the SCR, opting for smaller SCR equipment with longer catalyst life expectancy. The most toxic substance for the SCR operation is SO₃. SO₃ reacts with NH₃ (ammonia) to ammonium sulphate, which could block the catalyst. The less sulphur in the gas entering the SCR - the longer the life expectancy. The SCR may also be operated at a lower temperature without the risk of this clogging when sulphur content is low.

SCR treatment is known to be able to remove 80-95% of NO_x from the exhaust, making IMO's Tier III NO_x limit practically achievable, at least for higher engine loads which is a prerequisite for optimised SCR performance. A fuel consumption penalty can also be found using SCR, but this is not discussed further in this study focussing on SO_x removal.

Theoretically, there is a potential in removing CO₂ with a dry scrubber. This is due to the following reaction:



However, this will lead to higher CO₂ emission at the end because hydrated lime is made by calcination of limestone at 900°C:

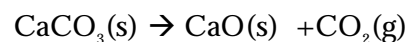

and subsequent cooling and hydration of the burned lime (CaO).

Implementation and practical use

At present, only one vendor is commercially offering the dry scrubber technology for marine application. They have also made one test installation onboard the cargo vessel MV Timbus carrying cellulose from Sweden to Germany and Holland. The system was approved by Germanischer Lloyd in April 2010.

The dry scrubber unit requires, at the present stage of development, significant space on board the vessel. Both the scrubber unit itself and the storage facilities for fresh and used granulate require valuable on board space. Granulate space requirement is obviously also a function of trade pattern and bunkering and disposal facilities.

The vendor, Couple Systems, assure supply of fresh granulate as required and plan to build a supply system for this in important harbours. In spite of the fact that hydrated lime is a readily available commodity, it could still pose limitations to which ships are suitable for this exhaust cleaning option.

Economic considerations

Dry scrubber systems available have the following estimated capital expenditures:

- 1 MW engine: USD 0.5 million
- 20MW engine: USD 4 million

Considering the modest amount of price related scrubber information available, the most outspoken conclusion will be to say that these prices are in the same ballpark as wet scrubber system prices.

Furthermore, the corresponding annual operating costs for dry scrubber systems from Couple Systems are:

- 1 MW engine: USD 43,500
- 20 MW engine: USD 477,200

These operating costs include power consumption, granulate, maintenance and labour.

It seems from the information collected that one advantageous aspect of dry scrubbers is power consumption. As a general number, the power consumption of dry scrubbers is about 10% of that of a wet scrubber for similar size engine (1.5 - 2 kW/MW engine power). This does not include energy consumption for production, transport and disposal of granulate.

The preferred way of dispose used granulate will be to leave the granulate with some active capacity. This residue will be an attractive product to on shore power plants for high temperature desulphurisation. Hence, used granulate will in most cases not contribute negatively to the dry scrubber technology.

3.2 Discharges, emissions and waste

3.2.1 SO_x scrubbers

The wet SO_x scrubber operating onboard a vessel has basically three discharge fractions:

- The wash water from the scrubber being directly discharged overboard or led to an onboard wash water treatment plant
- The sludge from an onboard wash water treatment plant or from the freshwater recirculation process
- The gaseous exhaust containing remaining pollutants not being removed in the scrubbing process

Wash water

One of the crucial questions regarding SO_x scrubbing is about wash water discharge: Once the scrubbing process has "gained control" over the pollutants transferred from the exhaust gas to the wash water, when - if ever - is it acceptable to completely discharge this fraction? Gregory et al. (2010) put it this way:

In addition to reducing sulphur oxides Exhaust Gas Cleaning Systems are very effective at reducing emissions of particulate matter and oil based material with removal rates in excess of 80% possible. Whilst particulate matter from un-scrubbed exhausts already enters ecosystems via the atmosphere it is not obviously desirable to shortcut this process and simply move the pollutants direct to sea. An effective wash

water treatment plant is therefore required that is capable of removing both particles and oil.

The wash water discharge rates are for obvious reasons very different for one time through seawater scrubbers and freshwater scrubbers running in re-circulation mode. The seawater scrubber will discharge the total amount of wash water at all times (except for a small amount of water in the sludge fraction where a wash water treatment plant is in operation). The freshwater scrubber will under normal conditions discharge a bleed off fraction to compensate for pollutant build-up in the process water.

The discharge rates for both systems will vary with individual scrubber system design, but for simplicity reasons acknowledged, general numbers are found in MEPC 58/23 Annex 16 (2008):

- Seawater discharge rate: 45 m³/MWh
- Freshwater bleed off rate: 0.1 - 0.3 m³/MWh (Indicated circulation rate freshwater: 20 m³/MWh)

According to MEPC 56/INF.5/Annex 1 (2007) wash water from wet scrubbers contains material from three sources:

- The exhaust gas exiting the engine (air, fuel, lubricant and combustion products)
- The seawater used to clean the exhaust
- The scrubber itself (possible reaction products and possible chemical additives).

In addition to these sources, contributions from tear and wear of the system components (engine, scrubber, pipes etc.), and corrosion e.g. by sea water, should be considered.

The composition of the wash water is initially discussed under cleaning performances above and further discussed in chapter 4-3 below where results from the investigations onboard the Ficara Seaways are presented.

Sludge

Where marine scrubbers are equipped with a wash water treatment plant, a sludge fraction is produced in parallel with the water discharge. This is valid for both seawater scrubbers where the wash water stream in total must be treated as well as for freshwater systems where the bleed-off stream are treated in any fitted treatment device.

Treatment technologies may vary and for seawater systems the challenge is to efficiently cope with vast amounts of wash water (~45 m³/MWh). Cyclones and flocculation systems are known to be in trial. The same treatment technologies are relevant for freshwater bleed-off treatment plants, but water quantities are considerably smaller (0.1 - 0.3 m³/MWh) and pollutant concentration considerably higher enabling a higher sludge "yield".

It is not permitted to incinerate the scrubber sludge onboard, hence requiring separate storage for onshore disposal.

Sludge generation numbers and sludge composition analyses are not frequently found in relevant literature as it seems the strongest focus so far has been on scrubber cleaning performance and wash water composition.

However, Wärtsilä (2010) report that the amount of sludge generated by their system is approximately 0.1 to 0.4 kg/MWh while Ritchie et al. (2005) indicate a sludge generation of 0.2 kg/MWh from the seawater scrubber onboard the ferry *Pride of Kent*.

The sludge sampling and analyses carried out as part of this project are presented in section 4.2. See also section 6.1 on characteristics of scrubber sludge.

Air emissions

Undoubtedly, the wet SO_x scrubber is reducing the polluting potential of the ship exhaust gas by removing sulphurous compounds, particulate matter and some metal compounds. However, there is still uncertainty about size distribution of the particulate matter captured in the scrubber. Whereas larger particles contribute more to visual air pollution, the smaller fractions (PM_{2.5} - particles smaller than 2.5 µm) represent the larger respiratory hazards. As described in section 3.1.1 above, the focus on this is increasing and research projects are being initiated.

The CO₂ emissions from a vessel with a wet scrubber will be higher as an acknowledged number for increased power consumption for the scrubber is 2% due to increased back pressure. This is reported from wet scrubber vendors Aalborg Industries (since spring 2011 part of the Alfa-Laval Group) and Hamworthy Krystallon. When the scrubber is operated in freshwater mode with NaOH additive, the manufacturing and logistics of the NaOH itself will contribute further to CO₂ emission. Aalborg Industries estimate an additional 2% of the fuel energy for this. Since NaOH in most cases is a bi-product from chlorine manufacturing, the CO₂ footprint for the energy used in this process is an important variable in this calculation.

The overall CO₂ emission picture related to scrubber use must be seen in connection with increased CO₂ emissions from refinery fuel desulphurisation. Hamworthy Krystallon (2007) discusses this further and indicates that the following CO₂ emission contributions can be found using a scrubber:

- 2 kg CO₂/GJ (energy in fuel) from the neutralisation process
- 1.6 kg CO₂/GJ (energy in fuel) from the scrubber operation

This in combination is still considerably less than refinery CO₂ emissions producing low sulphur distillate fuel. The corresponding number for this is reported to be:

- 10 kg CO₂/GJ (energy in fuel) from refinery operation

These numbers are indeed indicative. The allocation of energy to residual fuel at a refinery is based upon Concawe figures for average emissions and may vary from refinery to refinery.

3.2.2 EGR scrubbers (DeNO_x systems)

The EGR scrubber is basically a wet SO_x scrubber, although smaller than a regular exhaust gas scrubber treating only a dividend of the total exhaust gas stream from the engine (typically 20-40%).

The waste water discharges from EGR scrubbers should comply with the IMO scrubber water discharge criteria. Similar to the regular SO_x scrubber, significant amounts of suspended particulate matter are found in the wash water. The one known pilot installation of an EGR system (Alexander Maersk) therefore has a water cleaning unit installed, releasing the treated water to open sea in compliance with the regulations and directing the sludge into the ship sludge tank. Sludge generation rates and sludge composition are not found reported.

The air emissions after EGR will be lower on NO_x and SO_x as described in section 3.1.2 above. However, there will be an increase in air emissions due to EGR power consumption. Figures for this is not found reported. In addition, Gregory et al. (2010) report an increase in specific fuel consumption and carbon monoxide levels when the EGR system is operated for maximum NO_x removal rate. Adjustment of the engine set-up has been found to compensate parts of this penalty.

3.2.3 Inert gas cleaning scrubbers

Since inert gas generators and thereby inert gas scrubbers are considered safety equipment and they are only in operation in designated time intervals during unloading operation, discharge water is not regulated by the IMO scrubber wash water criteria.

There are little known wash water analyses from inert gas scrubbers. Due to the large water amounts used in inert gas scrubbers (0.015 m³/Nm³ gas) to comply with temperature requirements the concentrations of scrubbed components including particles are very low.

Commercially available flue gas systems with scrubbers operate with one time through scrubbing. There is no water treatment/cleaning units installed and hence no generation of sludge to be disposed of later. The produced soot particles are discharged directly to the sea.

3.2.4 Dry scrubbers

Dry scrubbers have no discharges to the marine environment. The used granulate is disposed of on shore. According to a manufacturer this residue will be possible to use by on-shore power plants for high temperature desulphurisation given some active capacity left in the granulate.

Dry scrubbers have a relatively low energy consumption compared to the wet scrubber systems (1.5 - 2 kW/MW engine power). Hence, the additional CO₂ emissions from the vessel operating a dry scrubber are correspondingly low. CO₂ footprint from manufacturing and transporting granulate will contribute, but is not investigated further in this study.

3.3 Near future development of scrubbers

The near future development of different scrubbers is a combination of obvious generic improvements and more innovative developments. The latter are in most cases connected with some secrecy from relevant manufacturers - making accurate predictions more difficult.

Also, legislative matters will influence the development of commercially available scrubbers in the years to come as the scrubber designs have unlike cleaning properties and potentials. This is illustrated by MEPC 56/INF.5/Annex 2 (2006):

As long as this situation with unclear rules prevails, owners continue to be reluctant to invest, and scrubbers will not enter the market. In case of too stringent criteria for heavy metals, legislation will encourage the selection of scrubbers with low particle removal rate, sending most of the particles to the atmosphere, and producing a clean effluent requiring no treatment plant. In case of too stringent criteria for pH, legislation will encourage the selection of scrubbers with limited SO_x-reduction rate (cleaning down only to an equivalent of 1.5 % S), sending much of the SO_x to the atmosphere. Legislation clearly preventing scrubbers from fully reducing emissions to the air will be deemed inappropriate by scrubber designers, presently in a need for design targets. The more obvious developments (which the manufacturers are not secretive about) are water flow reductions for wet sea water scrubbers and energy consumption for both sea water and fresh water scrubbers.

As a consequence of this legislative development, waste water guidelines will also be altered in the years to come as measurements become more numerous and experience grow, this report being a contribution.

The question about waste water treatment mentioned in section 3.2.1 above will also be further addressed in the near future as technologies for effective water treatment and sludge generation will be further tested and legislation may be correspondingly altered. This is mainly a topic for sea water scrubbers which are, without a wash water cleaning system, basically discharging all components removed from the exhaust gas in the scrubber process.

More trade based research and development projects are also in the pipeline. They are cooperative studies including research institutions. One study planned to commence April 2011 managed by MARINTEK in Trondheim including manufacturers and ship owners will focus on particulate matter and water effluent in scrubbing. One manufacturer will also install their commercially available wet scrubber (sequencing the pilot scrubber) at MARINTEK for testing purposes.

The generic developments of seawater SO_x scrubbers are believed to be related to reduced water flow rate and hence reduced power consumption. Hamworthy Krystallon (2007) estimates a future reduction in power consumption of about 50%, bringing the consumption down to 0.3 - 1.5 % of total power use (see Table 3-4).

One innovative aspect of future scrubbers are the challenge of making exhaust gas scrubbers with an effluent suitable to be inert gas onboard tankers. This will obviate the need to burn diesel fuel to make inert gas and significant CO₂ emissions. The main challenge is the O₂ content in the exhaust gas being typically 7-15% in engine exhaust, whereas the inert gas requirement is 8%.

Integration of different exhaust gas cleaning technologies will also be a part of the near future development. Already, scrubber technology is combined with SCR units to also reduce NO_x emissions. Exhaust gas scrubbers feeding an EGR system, eliminating the need for an internal EGR SO_x scrubber, is also being investigated.

For dry scrubbers, size is the foremost challenge along with further documenting granulate logistics along with ease and economics of residue recycling.

Dry scrubber manufacturer also indicates combining several exhaust gas cleaning technologies in one as a main target. Details are at the point of writing (March 2011) kept confidential.

3.4 Summary/comparative assessment

It must be concluded that as of 2011, 20 years after the first trial installation, marine use of scrubbers is still in an early stage of commercialisation.

However, scrubbers as exhaust gas cleaning systems are today commercially available and have proved to efficiently remove SO_x from the exhaust gas. Sulphur reduction rates are reported by vendors to be between 90 and 99%. The one available dry scrubber vendor reports 99% SO_x removal rate.

The operational perspective of the SO_x removal rate is to consider the maximum % sulphur in fuel the scrubber system can tolerate and still achieve air emissions equivalent to 0.1% sulphur in fuel. See Table 3-7 below.

Table 3-7 Summarising operational SO_x removal rate, sorted by scrubber type.

Scrubber type	Maximum % sulphur in fuel achieving air emissions equivalent to 0.1% sulphur in fuel
Switchable	3 - 3.5
Seawater	3.5
Freshwater	3.5 - 5
Dry	4.5

Engine size seems not to be a limiting factor. Vendors report scalable solutions, either as one large scrubber unit for high output engines or as smaller scrubbers combined when necessary.

The near future of scrubbers is believed to be influenced by the legislative regime developing. Reduced consumption of cleaning agents and hence reduced power consumption and physical scrubber sizes are already under development. New, improved combinations of emission abatement technologies are also soon to occur. See section 3-3 above.

Studies (e.g. Ritchie et al. (2005)) indicate scrubber technology as a very cost effective alternative to fuel switching. See section 3.1.1 for further details.

Table 3-8 Cost per ton of emissions reduced for SO₂ abatement measures versus fuel switching. See also footnote to Table 3-6.

Measure	Ship type	Small vessel (€/ton SO ₂)	Medium vessel (€/ton SO ₂)	Large vessel (€/ton SO ₂)
Sea water scrubbing	New	390	351	320
Sea water scrubbing	Retrofit	576	535	504
Fuel switching 2.7% -> 1.5%	New/ retrofit	2,053 (1,230)	2,050 (1,230)	2,045 (1,230)
Fuel switching 2.7% -> 0.5%	New/ retrofit	1,439 (1,690)	1,438 (1,690)	1,434 (1,690)

One question remaining is regarding treatment of the wash water. Once the scrubbing process has "gained control" over the pollutants transferred from the exhaust gas to the wash water, when - if ever - is it acceptable to completely discharge this fraction? Gregory et al. (2010) put it this way:

In addition to reducing sulphur oxides Exhaust Gas Cleaning Systems are very effective at reducing emissions of particulate matter and oil based material with removal rates in excess of 80% possible. Whilst particulate matter from un-scrubbed exhausts already enters ecosystems via the atmosphere it is not obviously desirable to shortcut this process and simply move the pollutants direct to sea. An effective wash water treatment plant is therefore required that is capable of removing both particles and oil.

The wash water discharge rates are for obvious reasons very different for one-time-through seawater scrubbers and freshwater scrubbers running in circulation mode. The seawater scrubber will discharge the total amount of wash water at all times (except for a small amount of water in the sludge fraction where a wash water treatment plant is in operation). The freshwater scrubber will under normal conditions discharge a bleed off fraction to compensate for sodium sulphate build-up in the process water.

4 Practical investigations

The practical investigations in this project have been carried out using the wet scrubber system on board the vessel Ficaria Seaways (Tor Ficaria until mid 2011) as study object.

Ficaria Seaways is a 230 metres long, 14,500 tonnes dead weight ro-ro vessel with a 21 MW engine. The vessel, built in 2006 and owned by DFDS, is operating out of Gothenburg, Sweden, with routine destinations in England (Immingham) and Norway (Brevik).

4.1 System description

In 2009, a wet scrubber system developed by Aalborg Industries (Denmark) (now part of the Alfa-Laval Group) was installed on Ficaria Seaways (Tor Ficaria), primarily with the aim to reduce emissions of sulphur dioxide and soot particles to the atmosphere. The scrubber is capable of operating in two different modes, a flow-through mode by direct intake of sea water (SW) and a circulation mode using fresh water (FW) from a tank.



Figure 4-1 Installation of the scrubber system on Ficaria Seawayas (Tor Ficaria) in 2009.

When operating in SW-mode the scrubber uses the natural alkalinity of sea water to absorb and bind SO_x from the exhaust gas while when operating in FW-mode addition of sodium hydroxide (NaOH) is necessary to maintain the slightly alkaline pH required. Eventually, after approx. 6 hours at MCR, the recirculated fresh water will be saturated with sodium sulphate and must be replaced. The used scrubber water must, after centrifugation to remove soot and other particles, be discharged or pumped to a reception facility on land.

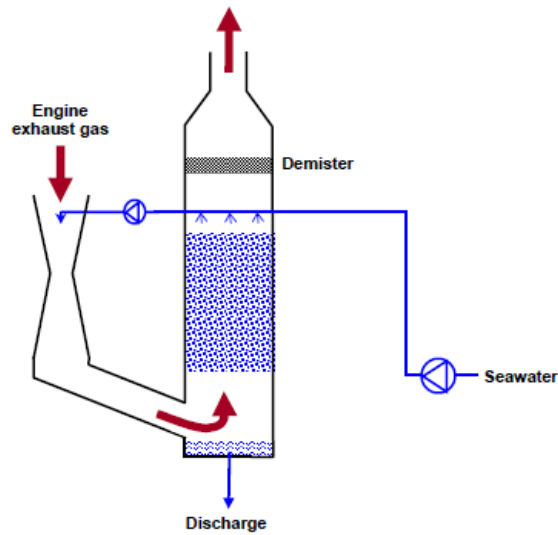

Figure 4-2 Schematic presentation of scrubber operating principle, SW-mode.

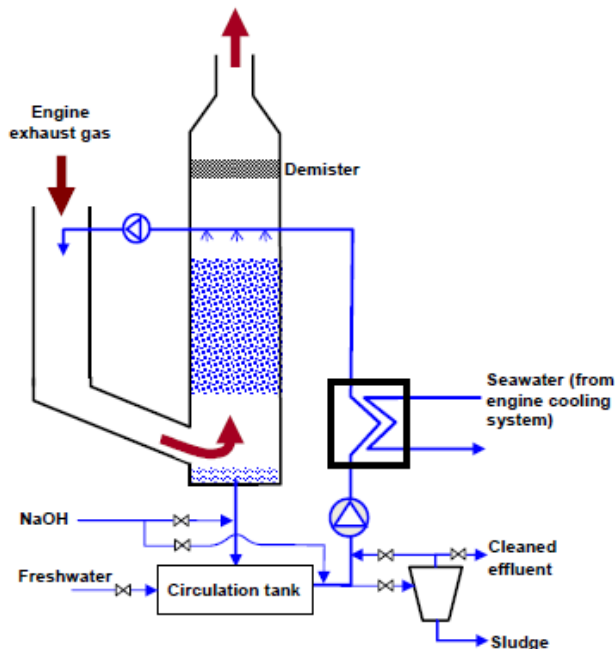

Figure 4-3 Schematic presentation of scrubber operating principle, FW-mode.

4.2 Investigation programme

The investigation programme on Ficara Seaways has comprised sampling of scrubber water, sludge on board the vessel on two occasions in early 2011 and subsequent chemical analyses undertaken by the contract laboratory Eurofins Denmark.

4.2.1 Sampling

The sampling has taken place on board Ficara Seaways operating between Gothenburg (S) and Immingham (UK). Originally, only one sampling round was planned but due to some technical complications not related to the

scrubber itself, a second sampling round had to be carried out a few weeks later to collect the missing samples of wash water from the scrubber in FW-mode and of the sludge produced in this mode.

On both occasions, Ficaria Seaways used HFO with 2.2 % sulphur in one sailing direction and HFO with 1.0 % sulphur on the return trip. Scrubber water samples were taken in both directions to investigate possible fuel type-related differences in composition of wash water and sludge. During operation of the scrubber in SW-mode, wash water samples were taken at two different engine loads (high load, approx. 85-90 % MCR, and low, 40-45 % MCR, respectively), while when operating the system in FW-mode the engine load was held constant at the high engine load. The scrubber water flow was kept constant at 1,000 m³/hour in SW-mode and at approx. 900 m³/hour in FW-mode.

The investigation programme comprised the following:

Heavy Fuel Oil (HFO):

Samples of the two types of HFO (2.2 % S, and 1.0 % S) were taken from the supply currently being used by the vessel (after flushing the tap properly) when the engine performance was considered to be stable.

Reference samples of water:

Reference samples of sea water (SW) were taken at open sea in each sailing direction using a tap on the intake side of the scrubber system. Approx. 8-10 liters of water were tapped and discarded before the SW reference samples were taken to minimise the risk of analytical errors due to possible releases of substances to stagnant water in the pipes.

The fresh water reference sample was taken from a tap in the water supply system (fresh water is generated on board the ship). Approx. 8-10 liters of water were tapped and discarded before the FW reference sample was taken to minimise the risk of analytical errors due to possible releases of substances to stagnant water in the pipes.

Scrubber water (SW-mode):

SW scrubber water was sampled in both cruise directions, i.e. representing powering by HFO, 2.2 % S and HFO, 1.0 % S, respectively. Further, with each fuel type samples were taken at two different engine loads, 85-90 % MCR and 40-45 % MCR, respectively. The samples were taken when stable engine performance conditions had been verified.

All SW samples were taken from a tap at an outlet point after the scrubber. Prior to taking the sample, approx. 8-10 liters of water was tapped and discarded to minimise the risk of errors/misinterpretations due to stagnant water in the pipes, which could either represent irrelevant scrubber conditions or be affected by releases of substances from the pipe system materials.

The samples were taken using a procedure known as "qualified spot sampling" according to a German guideline requiring each sample to be composed of five sub-samples of equal size taken with intervals of 2-4 minutes to minimise sensitivity to operational variations during sampling. The spot-samples were mixed in a large bucket from which the desired sub-samples were subsequently taken while continuously stirring to maintain homogeneity (avoid settling of suspended particles etc.).

Each composite sample was divided into two sub-samples, one to be analysed as a whole sample and the other to be analysed after filtration (standard laboratory filter; 0.45 µm).

Thus, in total eight SW scrubber samples were produced as shown in Table 4-1 below.

Table 4-1 Overview of SW scrubber samples taken.

Engine load	HFO, 2.2 % S		HFO, 1.0 % S	
	Whole	Filtered	Whole	Filtered
85-90 % MCR (high)	x	x	x	x
40-45 % MCR (low)	x	x	x	x

Scrubber water (FW-mode):

FW scrubber water was sampled in both cruise directions, i.e. representing powering by HFO, 2.2 % S and HFO, 1.0 % S, respectively. The samples were taken when stable engine performance conditions had been verified.

The investigation in FW-mode took place over a period of 2 hours (120 minutes) letting the scrubber water be re-circulated without concurrent removal of particles by centrifugation thereby enabling monitoring of the pattern of accumulation of contaminants in the scrubber water by sampling with 20 minutes intervals from t = 0 to t = 120 minutes. It should be mentioned that this is not the normal mode of operation, but applied here in order to obtain higher concentrations expected to be needed for quantitative analysis of trace pollutants.

All FW and SW-samples were taken from a tap at the same outlet point after the scrubber. Prior to taking the actual sample, approx. 8-10 liters of water was tapped and discarded to minimise the risk of misinterpretations due to stagnant water in the pipes, which could either represent irrelevant scrubber conditions or be affected by releases of substances from the pipe system materials.

The samples were taken by the same "qualified spot sampling" method as mentioned under sampling in SW-mode.

One sample (only as whole sample) was taken at the beginning of the investigation in FW-mode (t = 0), while a whole sample as well as a sample to be analysed after filtration were taken at t = 120 minutes.

Additionally, samples for determination of suspended particles were taken with 20 minutes intervals at t = 20, 40, 60, 80 and 100 minutes as a representation of the build-up of contamination in the scrubber water over time.

After the sampling at 2 hours, the operation of the scrubber was changed to SW-mode and the centrifuge was started to clean the FW-tank of particles. As soon as stable operation of the centrifuge had been obtained, a sample (whole sample) of the scrubber water was taken at an outlet point located immediately after the centrifuge. This water could be viewed as representative

of the composition of a possible discharge of scrubber water resulting from operation in FW-mode.

Sludge (FW-mode):

Sludge samples (FW-mode) were taken in both sailing directions, i.e. representing powering by HFO, 2.2 % S and HFO, 1.0 % S, respectively. The samples were taken as composite samples from the centrifuge to represent, as well as possible, the average composition of the sludge produced.

A centrifuge from Alfa Laval was kept in operation for about 6 hours in order to clean the volume of water in the system. The sludge from the centrifuge was “shot” out and collected in a 25 L can. The sludge, which was black and somewhat viscous (11 % dry matter content) was homogenised by continuous stirring while a number of sub-samples were collected to produce enough material for a composite sample to be subject to chemical analysis.

4.2.2 Chemical analyses

The analytical investigation programme comprised general parameters as well as several specific inorganic and organic substances as shown in Table 4-2 below.

Each sample taken consisted of a number of sub-samples collected in bottles or other containers specifically designed for each type of analysis.

Table 4-2 Overview of analytical parameters determined for each group of samples.

Parameter	Ref. water		Scrubber water			Sludge	HFO
	SW	FW	SW	FW	FW (centrif.)	2.2/1.0	2.2/1.0
pH *	X	X	X	X	-	X	-
Temp.*	X	X	X	X	-	-	-
Dissolved Oxygen*	X	X	X	X	X	-	-
SS	X	X	X	X	X	-	-
COD	X	X	X	X	X	-	-
Dry matter %	-	-	-	-	-	X	-
Lol / ash**	-	-	-	-	-	X	X
Total-N	X	X	X	X	X	-	-
S (sulphur)	X	X	X	X	X	X	X
Trace elements (As, Cd, Cu, Hg, Ni, Pb, V, Zn)	X	X	X	X	X	X	X
THC	X	X	X	X	X	X	-
PAH (16 USEPA)	X	X	X	X	X	X	-
PCB	-	-	-	-	-	X	-
PCDD / PCDF	-	-	-	-	-	X	-

* On-line determination on board Tor Ficaria
** Loss on Ignition (sludge); ash (fuel)

4.3 Results and discussion

4.3.1 Fuel analyses

Analyses of selected substances in the two types of HFO used at Ficaria Seaways during the first round of the sampling campaign were carried out and gave the results presented in Table 4-3 below. The fuels (used for testing of the scrubber) contained 2.2 % S and 1.0 % S (nominally), respectively. Additionally, a marine gas oil (MGO) with nominally 0.1 % S was analysed later for comparative purposes. The result of this analysis is also included in the table.

It appears that the analysed sulphur content in the two fuel samples are acceptably close to the nominal values i.e. within approx. 5 %.

For most of the analysed trace elements, the fuels contain lower amounts than the LOQ (limit of quantification). With regard to nickel and vanadium the analyses show correspondence between the sulphur content and the content of these two metals.

Table 4-3 Content of sulphur and trace elements in two types of HFO used on-board Ficaria Seaways during the sampling campaign. Data on an MGO with 0.1 % S analysed later is included for comparison.

Substance	Unit	HFO, 2.2 % S	HFO, 1.0 % S	MGO, 0.1 %S
Sulphur	g/kg	21.35	9.45	1.8
Arsenic (as)	mg/kg	<0.5	<0.5	<0.5
Lead (Pb)	mg/kg	<1	<1	<1
Cadmium (Cd)	mg/kg	<0.1	<0.1	<0.1
Copper (Cu)	mg/kg	<3	<3	<3
Mercury (Hg)	mg/kg	<0.2	<0.2	<0.2
Nickel (Ni)	mg/kg	42	22	3
Vanadium (V)	mg/kg	150	36	<1
Zinc (Zn)	mg/kg	<20	<20	<20

4.3.2 Scrubber water, SW-mode

The main results of the chemical analyses conducted on the water samples from the scrubber operating in SW-mode are presented in Table 4-4 below. pH was measured on board using the on-line registration system installed on Ficaria Seaways while all other parameters and substances were determined in the laboratory.

All wash water samples ("scrubber water") were analysed as whole samples as well as filtered samples as described in Section 4.2.1. However, with the exception of polycyclic aromatic hydrocarbons (PAH) the differences between the two sets of results were so small, and partly unsystematic, that only the results of the whole sample analyses are presented here. The content of PAH in the filtered samples is included in the table.

Typically, it would be expected that not only PAH but also most metals to a reasonably high extent would be associated with particulate matter in water samples. A possible explanation why this is not so in these samples could be

the high level of chloride in sea water (metal chlorides are usually quite soluble in water) combined with a rather low content of particulate matter in the water. PAHs do not form bonds with sea water ions and are also to a higher degree associated with particulate matter already in the exhaust gas.

Nitrogen (tot-N) and sulphur (tot-S) are presumably present in the samples predominantly as nitrates and sulphates, which do not appreciably adhere to particles, and neither do aliphatic petroleum hydrocarbons (THC components).

Table 4-4 Results of chemical analyses of wash water from the scrubber operating in SW-mode using fuels with different contents of sulphur (HFO with 2.2 % S and 1.0 % S, respectively) at two different engine loads (high and low) and scrubber water flow constant at 1,000 m³/hour. The samples were analysed as whole samples i.e. they were not filtered prior to analysis.

Substance/parameter	Unit	Sea water ¹	Wash water from scrubber (SW-mode) ²			
			2.2% S, High load	2.2 % S, Low load	1.0 % S, High load	1.0 % S, Low load
<i>Fuel consumption</i>	kg/h	-	3510	1850	3360	1830
<i>General and inorganics</i>						
pH	-	7.8	3.7	5.2	5.5	5.8
Suspended solids (SS)	mg/L	14	14	10	15	12
COD	mg/L	44	52	56	48	46
Sulphur (tot-S)	mg/L	865	900	900	890	870
Nitrogen (tot-N)	mg/L	0.12	0.56	0.34	0.36	0.22
<i>Metals</i>						
Arsenic (as)	µg/L	1.5	<1.0	1.8	<1.0	<1.0
Lead (Pb)	µg/L	<0.20	21	3.6	5.8	3.8
Cadmium (Cd)	µg/L	<0.20	<0.20	<0.20	<0.20	<0.20
Copper (Cu) ³	µg/L	5.0	260	150	110	150
Mercury (Hg)	µg/L	0.12	0.086	0.092	0.099	0.064
Nickel (Ni)	µg/L	8.9	43	20	19	9.1
Vanadium (V)	µg/L	1.8	180	81	49	25
Zinc (Zn) ³	µg/L	<2.0 - 8.0	450	150	110	98
<i>Total hydrocarbons (THC)</i>						
Sum, benzene - C35	µg/L	N/A	110	140	330	200
PAH (16 USEPA)	µg/L	N/A	0.96	1.1	1.8	1.6
- hereof naphthalene	µg/L	N/A	0.48	0.51	0.52	0.57
PAH, filtered sample	µg/L	N/A	0.62	0.65	0.78	0.86

N/A = not applicable. All individual components were below the limit of quantification (LOQ), i.e. the content of THC is < 20 µg/L and the sum of PAH < 0.16 µg/L.

¹ Ref. sample. Mean of two samples (taken at day 1 and 2 of the sampling, respectively).

² High load = 85-90 % MCR; low load = 40-45 % MCR.

³ The levels of copper and zinc are much higher than would be expected from the contents in the fuel used. Possibly a contamination source exist, which could possibly be the tap (made of brass or bronze) used for the sampling (despite prior flushing). This hypothesis has not been verified.

It is noted that despite the high natural content of sulphur in sea water (as sulphate) a (small) increase in the S-content after the scrubber can be observed. A small trapping of NO_x in the scrubber is indicated by the tot-N levels.

In Table 4-5 a rough calculation of the apparent "absorption efficiency" is presented for the two main trace metals present in the fuel, nickel and vanadium. The ability of the scrubber to trap these two metals from the exhaust gas appears to be limited.

Table 4-5 Nickel and vanadium in scrubber water as function of fuel type (content of sulphur) and engine load (high or low, % of MCR). Content of nickel and vanadium in ref. sea water subtracted. Scrubber water rate: 1000 m³/h.

Substance/parameter	Unit	Wash water from scrubber (SW-mode) ¹			
		2.2 % S, High load	2.2 % S, Low load	1.0 % S, High load	1.0 % S, Low load
<i>Fuel consumption</i>	kg/h	3510	1850	3360	1830
<i>Amount in fuel</i>					
Nickel	kg/h	0.15	0.078	0.074	0.040
Vanadium	kg/h	0.53	0.28	0.121	0.066
<i>Amount in wash water</i>					
Nickel	kg/h	0.034	0.011	0.010	"0"
	g/kg fuel	0.010	0.006	0.004	"0"
Vanadium	kg/h	0.171	0.072	0.047	0.016
	g/kg fuel	0.049	0.039	0.014	0.009
<i>Captured by scrubber</i>					
Nickel	%	23	14	14	<1
Vanadium	%	32	26	39	24

¹ High load = 85-90 % MCR; low load = 40-45 % MCR.

A similar calculation for sulphur cannot be performed because of the high natural content of sulphate in sea water, i.e. the increase in S-level in the washwater is small compared to the natural level and an efficiency estimate thereby very vulnerable to variability caused by sampling and analysis.

Neither is the calculation possible for hydrocarbons and PAHs, but this is because the source strength of these substances is not known. The amount of PAHs captured in the scrubber water in SW-mode is about 1.0-1.8 grams/hour corresponding to between 0.3-0.9 mg/kg fuel. Without naphthalene about 0.1-0.6 mg PAHs is present in the wash water per kg fuel consumed.

It is noted that the level of PAHs does not differ very much and that there is no apparent correlation with sulphur content in the fuel or with engine load. The level of naphthalene is almost constant in the wash water samples. If not taking naphthalene (often not considered to be a real PAH) into account, between 52 % and 72 % of the total amount of PAH is associated with particles (larger than 0.45 µm, the pore size of a standard laboratory filter).

Finally, the enrichment of the wash water samples with copper should be mentioned. The copper concentration in reference sea water was found to be about 5 µg/L while the wash water contained 110-260 µg/L of copper. This is surprising as the level in fuel was below the LOQ (3 mg/kg fuel), which therefore can only account for a content of approx. 10 µg copper/L wash water, at the most. The source of the copper enrichment remains unexplained.

Also zinc is found to be enriched (up to 100-450 µg/L) despite low levels of this metal in sea water (max. 8 µg/L) and in the fuel used (<20 mg/kg). However, for zinc some correlation with fuel type and engine load seems to exist but an actual explanation of the observations cannot be given. The maximum contribution of zinc from the fuel is approx. 70 µg/L.

Thus, it is possible that for these two metals a source of contamination was present, which could possibly be the tap used for the sampling - despite flushing prior to sampling - as the material was either brass or bronze and the tap is only rarely used for other purposes. It has not been possible to verify this hypothesis within the framework of the study.

4.3.3 Scrubber water, FW-mode

The main results of the chemical analyses conducted on the water samples from the scrubber operating in SW-mode are presented in

Table 4-6 below.

pH was measured on board using the on-line registration system installed on Ficaria Seaways while all other parameters and substances were determined in the laboratory.

Wash water samples ("scrubber water") taken after 120 minutes of scrubber operation in FW-mode, were analysed as whole samples as well as filtered samples as described in Section 4.2.1. However, the differences between the two sets of results were so small, and partly unsystematic, that only the results of the whole sample analyses are presented here.

No obvious explanation of this apparent lack of particle association of substances such as metals and PAH has been found.

It is noted that centrifugation of the wash water after 120 minutes leads to significant reduction in the concentration of suspended solids and some reduction in COD (see

Table 4-6). Reduction in concentration is observed for some metals, while for others there is no reduction. PAH-levels also become somewhat lower by sample centrifugation.

Table 4-6 Results of chemical analyses of wash water from the scrubber operating in FW-mode (re-circulation of scrubber water) using fuels with different contents of sulphur (HFO with 2.2 % S and 1.0 % S, respectively) at an engine load fixed at approx. 85-90 % of MCR and scrubber water flow held constant at about 900 m³/hour. The samples were analysed as whole samples i.e. they were not filtered prior to analysis. Sampling at 0 and 120 minutes after start of the scrubber in FW-mode. A sample of wash water following centrifugation after 120 min was also taken.

Substance/parameter	Unit	Wash water from scrubber FW-mode, HFO 2.2 % S			Wash water from scrubber FW-mode, HFO 1.0 % S		
		T = 0	T = 120	T = 120 centrif.	T = 0	T = 120	T = 120 centrif.
<i>Fuel consumption</i>	kg/h	0	3520	3520	0	3490	3490
<i>General and inorganics</i>							
pH	-	5.9	6.5	-	6.2	7.0	-
Suspended solids (SS)	mg/L	91	350	25	85	220	39
COD	mg/L	450	1000	440	300	800	490
Sulphur (tot-S)	mg/L	1800	6400	9000	1500	4500	4800
Nitrogen (tot-N)	mg/L	24	120	120	25	55	86
<i>Metals</i>							
Arsenic (as)	µg/L	3.4	12	9.8	3.5	10	8.8
Lead (Pb)	µg/L	24	29	3.8	19	17	1.6
Cadmium (Cd)	µg/L	<0.05	<0.05	0.094	<0.05	0.063	<0.05
Copper (Cu)	µg/L	560	740	860	470	500	390
Mercury (Hg)	µg/L	0.083	0.12	<0.05	<0.05	0.089	<0.05
Nickel (Ni)	µg/L	1200	4500	3100	930	2200	1300
Vanadium (V)	µg/L	4600	17000	14000	3400	7600	6100
Zinc (Zn)	µg/L	510	280	420	270	150	160
<i>Total hydrocarbons, THC</i>							
Sum, benzene - C35	µg/L	500	4500	11000	5400	29000	21000
PAH (16 USEPA)	µg/L	9.2	16	3.8	16	30	24
- hereof naphthalene	µg/L	0.71	0.71	0.32	0.75	0.82	0.49

The build-up of contaminants in the wash water, as represented by the analyses of suspended solids (SS) in samples taken with 20 minutes intervals from start to termination of sampling after 2 hours, shows relatively good linearity over the whole sampling period (see Figure 4-4). The shape of the curves on the figure indicates that the wash water had not reached its point of saturation with contaminants by the end of the sampling period.

When scrubbing exhaust gas from the engine while powered by HFO with 2.2 % sulphur, the accumulation is found to be approximately 75-85 mg SS/liter per hour and while powered by HFO with 1.0 % sulphur the accumulation is about 60 mg SS/liter per hour.

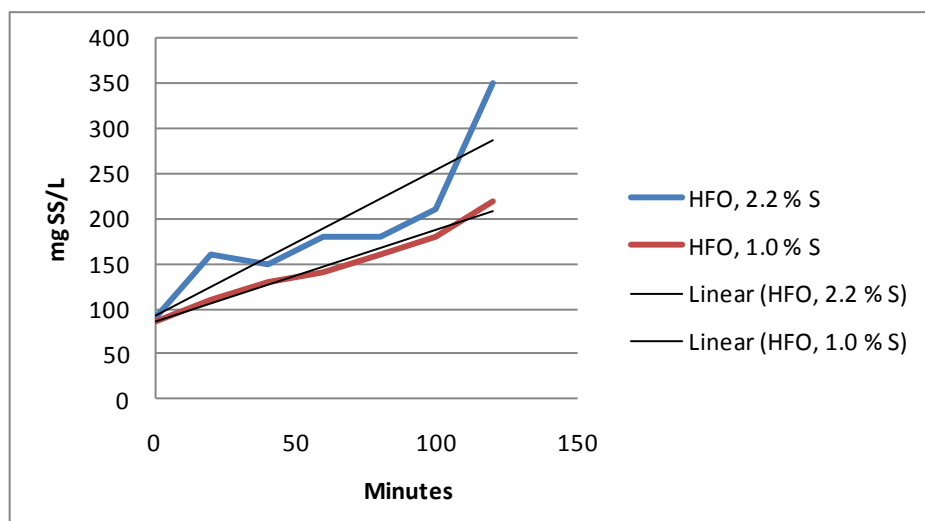

Figure 4-4 Accumulation of suspended solids (SS) in wash water from scrubber in FW-mode (closed loop) over a 2 hours test period.

For some of the substances being present in the wash water above the LOQ and showing an accumulation over the 2-hours test period in FW-mode, a rough calculation of the accumulation as a function of HFO consumed by the main engine has been made, which is presented in Table 4-7.

Table 4-7 Amount of selected substances captured in wash water from scrubber in FW-mode per kg fuel used (HFO for main engine at 85-90 % MCR). Circulation of wash water in scrubber: 900 m³/hour.

Substance/parameter	Unit	Amount captured in wash water	
		HFO, 2.2 % S	HFO, 1.0 % S
Fuel consumption	kg/ 2h	7000	7000
Volume of scrubber water (FW)	m ³	22	21
Suspended solids	g/kg fuel	0.81	0.40
Sulphur	g/kg fuel	14.5	9.0
Nickel	g/kg fuel	0.010	0.004
Vanadium	g/kg fuel	0.039	0.013
THC (sum, benzene-C35)	g/kg fuel	0.013	0.071
PAH (16 USEPA)	mg/kg fuel	0.021	0.042

When comparing the figures for nickel and vanadium in Table 4-7 (in terms of gram produced/kg fuel) with the corresponding figures in Table 4-5, a very good agreement between the two sets of values is found.

The other metals occur in the wash water (FW) in amounts at or below 0.5 mg/kg fuel, i.e. significantly lower than nickel and vanadium, while PAH is being captured in wash water (FW) in amounts below 0.05 mg/kg fuel (for the sum of the 16 US EPA PAHs).

4.3.4 Sludge, FW-mode

Samples were taken of the sludge produced during operation of the scrubber in FW-mode with both fuel types. The analytical programme included the same contaminants as analysed in the wash water but the sludge was additionally analysed for possible content of polychlorinated dibenzodioxins and dibenzofurans (PCDD/PCDF) and polychlorinated biphenyls (PCB). The main results of the sludge analyses are presented in Table 4-8.

Table 4-8 Results of chemical analyses of sludge produced during operation of the scrubber in FW-mode.

Substance/parameter	Unit	Sludge (HFO, 2.2 % S)	Sludge (HFO, 1.0 % S)
<i>General and inorganics</i>			
pH	-	7.1	7.2
Dry weight (dw)	%	11	11
Loss on ignition	% of dw	51	59
Sulphur	mg/kg dw	79000	52000
<i>Metals</i>			
Arsenic (as)	mg/kg dw	8.4	7.0
Lead (Pb)	mg/kg dw	54	31
Cadmium (Cd)	mg/kg dw	0.080	0.11
Copper (Cu)	mg/kg dw	1100	1400
Mercury (Hg)	mg/kg dw	<0.050	<0.050
Nickel (Ni)	mg/kg dw	5400	4200
Vanadium (V)	mg/kg dw	12000	6000
Zinc (Zn)	mg/kg dw	260	210
<i>Organics</i>			
THC, sum benzene-C35	mg/kg dw	111000	77000
PAH (16 USEPA)	mg/kg dw	230	220
PCB (7 congeners)	mg/kg dw	<0.0010 (each)	<0.0010 each
PCDD/PCDF (1-TEQ)	ng/kg dw	26.3	16.2

The values for loss on ignition indicate, as could be expected, a high content of organic matter, more than 50 %, presumably mainly consisting of soot particles and THC (approx. 100 g/kg dw).

The level of metals in the sludge is mostly relatively modest and for cadmium, lead, mercury and zinc below the Danish quality standards for sewage sludge to be applied on agricultural soils (in Statutory Order No. 1650 of 13.12.2006). The contents of copper and nickel are slightly higher than stipulated in the standard, while no standards exist for arsenic and vanadium.

The content of hydrocarbons (THC), presumably originating from the heavy fuel oil used and from lubricating oils and grease, is rather high. The mean value of THC in the two sludge samples is close to 100 g/kg dw corresponding to approx. 10 %.

The PAH level, 220-230 mg/kg for the sum of PAH, is considerably above the Danish limit for application of sludge on soil (3 mg/kg dw). The main components are phenanthrene and chrysene/triphenylene making up approx. 1/4 and 1/5 of the total amount, respectively.

The content of chlorinated dioxins and furans (PCDD/PCDF), expressed in international toxicity equivalents (I-TEQ, relative to "Seveso dioxin", 2,3,7,8-tetrachlorodibenzo-p-dioxin), is considered rather modest, only slightly above the average for Danish sewage sludge (10 ng I-TEQ/kg dw) and e.g. below the German standard for application of sludge on agricultural soils (100 ng I-TEQ/kg dw).

5 Assessment of impact on the marine environment

5.1 Overall approach and delimitations

This chapter presents an assessment of the impact on the marine environment if exhaust gas scrubbers on ships are introduced as an alternative technology to reduce SO₂ emissions from ships instead of using low-sulphur fuels.

The assessment is generic, i.e. it assesses the overall marine environmental consequences of the introduction of the scrubber technology using the principles and acceptability criteria used in the EU for the assessment of effects of chemical substances in the aquatic environment. The assessment is made in an ECA area context but does not otherwise take into account possible particular issues or rules related to geographic sub-areas with special status that may exist, e.g. Natura2000 areas. Nor does it address possible concerns and objectives of a more political nature such as e.g. the agreements under OSPAR and HELCOM aiming to reduce the marine levels of various hazardous substances to background levels within a certain span of years ("generation goal").

Other emissions and discharges from a variety of on-shore and off-shore sources also add (significantly) to the total load of sulphur, heavy metals and other substances on the marine environment. However, the scope of this study does not comprise quantification of this total load or of the fraction hereof originating from scrubbers. Thus, for an actual risk assessment relating to a particular (sub)area, the cumulative level and load of the relevant substances from all sources (e.g. sewage effluents, runoff, atmospheric fallout) in that area must be taken into account.

The specific framework and methodology of the assessment is described in more detail in section 5.2 below, including the definition of emission scenarios and the model areas selected for the generic assessment, and the anticipated intensity and composition of the ship traffic.

5.2 Framework of the assessment

5.2.1 Impact scenarios

Three scenarios are defined for the marine impact assessment in this chapter:

- "All ships scenario"
The impact if all ships are equipped with SO_x scrubbers by 2015
- "One ship scenario"
The impact of one ship equipped with SO_x scrubber (local impact)
- "No scrubbers scenario"
For comparison, the situation where no ships have exhaust gas scrubbers

installed by 2015 but instead use low sulphur fuel (0.1 % S) is considered.

"All ships" are for practical purposes defined as all ships bigger than 2,000 tons as the vast majority of smaller vessels will probably not install scrubbers but rather change to low sulphur fuel (the investment costs of scrubbers being too high for small vessels) or LNG on new builds. The "Ficaria Seaways", being a medium size ro-ro vessel with a 20 MW engine, is used to exemplify the "one ship" scenario.

5.2.2 Impact types considered

Only the releases of pollutants from (wet) exhaust gas scrubbers into the marine environment are considered in this chapter while issues related to sludge and other wastes to be treated and disposed of on-shore are addressed in Chapter 6.

The pollution loads relevant to consider in relation to washwater discharges to the marine environment are the trapped sulphuric acid/sulphates and the environmentally hazardous substances associated either with the fuel used, the engine and the scrubber system, or being generated in the combustion process (the generation of power) e.g. heavy metals, petroleum hydrocarbons and, with regard to the latter process, compounds such as PAHs and dioxins.

NO_x is not addressed in the assessment because wet scrubbers do not appreciably trap this pollutant and the impact difference between the two main scenarios (all ships with respectively without scrubbers) therefore will be marginal. Neither do scrubbers trap carbon dioxide (CO₂), and therefore no detailed assessment of this greenhouse gas is included. The operation of a wet scrubber does require some additional power leading to a higher emission of CO₂ from ships with scrubbers. However, the removal of sulphur from fuel is also associated with energy consumption (and CO₂ emission) on-shore, which could be higher than required for the operation of a scrubber. There is concern that the increase in global CO₂ emissions may in the long term lead to lowering of the pH of the oceans worldwide.

EC Directive 2008/105/EC, "...on environmental quality standards in the field of water policy...", is a daughter directive to the Water Framework Directive (Directive 2000/60/EC), which stipulates thresholds (standards) and actions to obtain "good ecological quality" of surface waters in the Member States including the surrounding coastal waters. The EU standards are presently being adhered to also by OSPAR and HELCOM and, thus, they are also valid for the marine environment in the North and Baltic Sea ECA areas outside the national territorial waters.

For some substances two sets of EQS exist, an annual average EQS (AA-EQS) and a maximum allowable concentration (MAC-EQS). The AA-EQS are meant to protect the aquatic organisms including the most sensitive life stages also in the long term (continuous emissions) while the MAC-EQS only addresses the risk of acute toxic effects and is only applicable to "intermittent releases". These are releases that have a short duration (less than 24 hours) and only occur occasionally (less than once per month on the average). For some substances only an AA-EQS has been established.

For a few substances the Danish Ministry of Environment has established more stringent criteria for the inland waters and national territorial waters (by Statutory Order No. 1022 of 25 August 2010). These values are taken into consideration in the assessment of the coastal waters, which, presumably, are more vulnerable to pollution than the open sea.

An overview of the substances identified in SW- and FW-washwater on board "Ficaria Seaways" when powered by HFO with 2.2 % S is presented in Table 5-1 together with the Environmental Quality Standards (EQS) to be complied with according to EC Directive 2008/105/EC or current national Danish quality standards. Only the highest value measured for each substance is included in the table.

Table 5-1 Contents of sulphur, metals and organic hazardous substances in SW- and centrifuged FW-washwater from the exhaust gas scrubber on Ficaria Seaways compared to current EU or Danish EQS (EU EQS / Danish EQS) for the marine environment.

Name	SW-washwater Flow-through, HFO 2.2% S with particles* (µg/L)		FW-washwater 2 h circ., HFO 2.2% S without particles (µg/L)	EU EQS / Danish EQS Marine environment (µg/L)**	
	High load	Low load	High load	AA-EQS ¹	MAC-EQS ¹
Sulphur (mg/L)	900	900	9000	-	-
Arsenic (As)	<1.0	1.8	9.8	- / 0.11	- / 1.1
Lead (Pb)	21	3.6	3.8	7.2 / 0.34	na / 2.8
Cadmium (Cd)	<0.20	<0.20	0.094	0.2	0.45 - 1.5
Copper (Cu)	260	150	860	- / 1.0	- / 2
Mercury (Hg)	0.086	0.092	<0.050	0.05	0.07
Nickel (Ni)	43	20	3100	20 / 0.23	- / 6.8
Vanadium (V)	180	81	14000	- / 4.1	- / 57.8
Zinc (Zn)	450	150	420	- / 7.8	- / 8.4
Benzene - C10	<2.0	<2.0	16	8 ²	50 ²
C10 - C25	55	52	4400	-	-
C25 - C35	58	88	6600	-	-
Sum, benzene-C35	110	140	11000	-	-
ΣPAH	0.96	1.1	3.8	-	-
Naphthalene	0.48	0.51	0.32	1.2	na

Name	SW-washwater Flow-through, HFO 2.2% S with particles* (µg/L)		FW-washwater 2 h circ., HFO 2.2% S without particles (µg/L)	EU EQS / Danish EQS Marine environment (µg/L)**	
	High load	Low load	High load	AA-EQS ¹	MAC-EQS ¹
Benzo(a)pyrene	<0.010	<0.010	<0.010	0.05	0.1
ΣBenzo(b+k)fluoranthene	<0.010	<0.010	0.10	0.03	na
ΣBenzo(ghi)perylene + Indeno(123-cd)pyrene	<0.020	<0.020	<0.020	0.002	na

* Not adjusted for possible background concentrations in natural sea water (low for most substances but high for sulphur: 865 mg/L).

** For metals the EQS refers only to the dissolved fraction, not the total content.

¹ AA-EQS = Annual average EQS; MAC-EQS = Maximum allowable concentration EQS.

² Benzene only.

na = not applicable (according to EC Directive 2008/105/EC).

It appears from the table that for many of the substances found in the washwater effluent from the scrubber on board "Ficaria Seaways", the effluent concentration is higher than the EQS to be complied with. Therefore, it must be mentioned that the EC Directive does not necessarily require compliance with the EQS at the discharge point but at the edge of a mixing zone with a permissible size depending on the specific circumstances and nature of the water body in question.

The results from the investigations on "Ficaria Seaways" are used for the general marine impact assessment in this report as both the size of this vessel and the wet scrubber system installed are considered to be reasonably representative of the average of vessels operating in the Baltic Sea ECA in a theoretical future situation with widespread implementation of scrubbers for exhaust gas cleaning.

Only few other relevant data are available for comparison with and to support the use of Ficaria Seaways data. However, the results of analyses of the discharge water from the SO_x scrubber on the vessel "Fjordshell" (10 MW 2-stroke engine) (Buhaug et al., 2006) are in line with the results from Ficaria Seaways for sulphur, THC, PAH and most metals with the exception of copper and zinc, which occurred at significantly higher concentrations in Ficaria Seaways's discharge water. Results on PAHs from the MS Zaandam (Young, 2011) differ from the Ficaria Seaways data by only a factor 2. Thus, the few other relevant data available support the use of the data from Ficaria Seaways for the marine impact assessment in this report.

For the purpose of the impact assessment of sulphuric acid, complete (100 %) trapping by the scrubber of the sulphur contained in the fuel used is assumed to provide the most conservative estimate in relation to impact on the marine environment. For the other contaminants the maximum contents determined in the washwater is used as the basis.

As a "rule of thumb" the consumption and discharge of sea water from a wet scrubber operated in flow-through mode (SW-mode) is 50 m³/hour per MWh (Hansen, J.P., Alfa Laval DK, pers. comm.).

Thus, on "Ficaria Seaways" (20 MW engine) the washwater discharge volume in SW-mode is 1,000 m³/hour while for operation in FW-mode (circulation mode) the FW tank volume of approx. 20 m³ is circulated at 900 m³/hour.

5.2.3 Study areas

Geographically, two sub-areas within the Baltic Sea ECA area have been selected for the impact assessment:

- The Kattegat to represent an open and, from a hydrographic point of view, relatively uniform sea area different to the adjacent regions Skagerrak and the Belt Sea, respectively. Further, the Kattegat is characterised by relatively intense ship traffic,
- Aarhus Bight to represent a more confined (more shallow, less current) and thereby potentially more vulnerable area than the Kattegat. The ship traffic in the bight, mainly to the city of Aarhus, is significant.

The two study areas are shown in Figure 5-1 and Figure 5-2, respectively.

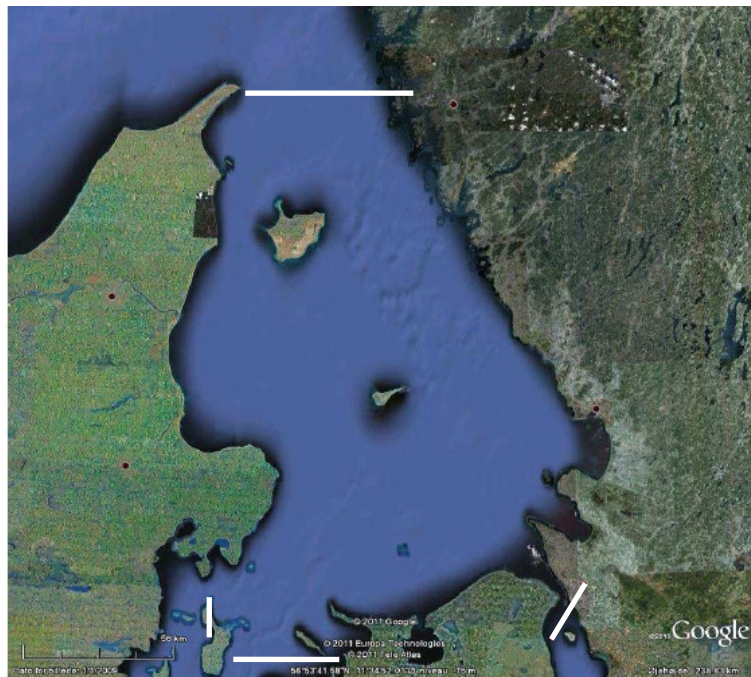

Figure 5-1 Study area for the Kattegat (Kort & Matrikel styrelsen, 2000).



Figure 5-2 Study area for the Århus Bight (Kort & Matrikelstyrelsen, 2000).

The modeling of effluent dispersal (mixing) is determined based on the principles of Time Scale for a water body. The period of time between the discharge start and until a stationary situation is achieved is described with the term Time Scale. In principle, it takes infinitely long time to reach such state, therefore the term Time Scale is mostly mentioned together with the fraction of the concentration compared to the stationary concentration.

The mixing is calculated based on the basic assumption of a well mixed water body. The assumption of a well mixed water body can be used when the mixing is so strong that concentration gradients within the water body are small compared to the change of the overall concentration level. The theory of a well mixed water body implies that the concentration after a change in the load conditions will adjust towards the final, stationary level following an exponential function. The assumption of a well mixed water body has the advantage that the concentration in a specific water body can be calculated based on the time scale, the volume of the water body and the discharge of the substance.

Whereas the discharge of substances and the volume of the water body can be determined relatively easy, the term time scale requires background studies. The time scale expresses the time period until a concentration level has adapted to a new situation. Typical time scales are $T_{50\%}$ and $T_{90\%}$, which describe the time until 50% or 90% of the final concentration levels are reached after a sudden change of load. In scientific analysis the time scale $T_{63\%}$ is often used.

For the purpose of modeling the mixing and dispersal of the wastewater effluents the following data on the two selected study areas are used:

The **Kattegat** is approx. 220 km long and 100 km wide with a total volume of approx. 515 km³ and a mean depth of 23 m (Nielsen, 2000). An average

interface is placed between 15 and 20 m depth, giving an upper mixed water mass of approx 300 km³.

In (Poulsen, 1991) the average outflow from the Kattegat is estimated to 62.000m³/s. Since this outflow occurs through the upper layer the average residence time in the upper layer can be estimated to be 62 days or about 2 months. This time scale corresponds to the time when approx 63% of the end concentration is reached.

The **Aarhus Bight** is approx. 20 km long and 20 km wide with a total area of approx. 400 km². An average interface is placed at 15 m depth, giving an upper mixed water mass of approx 6 km³.

In (Sømod 2005), the time scale for mixing in the Aarhus Bight is determined as the period where the amount of initial concentration of a tracer substance is reduced by 90% (10% are left). Based on hydraulic modeling the T_{10%} is found to be 20 days. Based on this the average discharge can be determined to be 9.100m³/s.

5.2.4 Ship traffic

AIS (Automatic Information System) data covering a period of one year (01.07.2008 - 30.06.2009) are used to determine the magnitude and composition of the ship traffic in the two areas. The AIS describes the information submitted every 2-5 minutes by all vessels larger than 300 BRT about ID, course, speed, load, etc. The information is submitted to the national authorities, in Denmark the Admiral Danish Fleet (SOK), to have a clear picture of the traffic situation and to identify ships with unusual behaviour.

The ship traffic intensity in Kattegat and in Aarhus Bight is illustrated in Figure 5-3 below (based on AIS data).

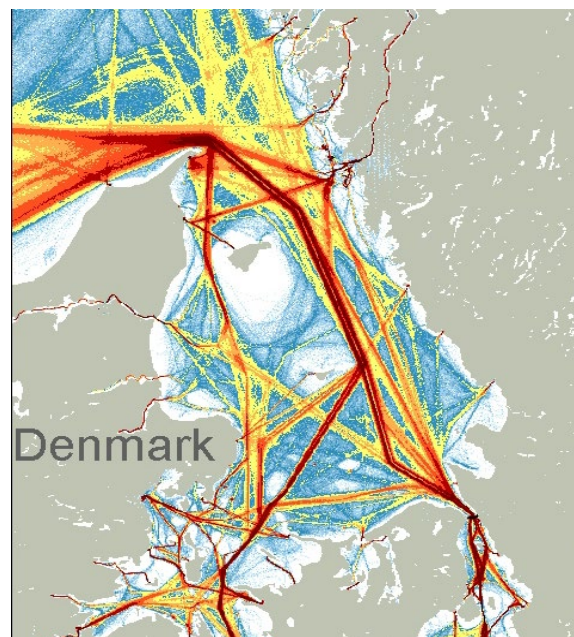

Figure 5-3 Illustration of the ship traffic intensity in the Kattegat and Aarhus Bight.

AIS divides the ship traffic into 24 categories of vessels, which is deemed far too detailed for the assessment in this report (considering the amount of data available). Therefore, the composition of the ship traffic in the two study areas has been simplified by grouping the original 24 categories into the following five main categories:

- Bulk and general cargo
- Tankers, crude oil and chemicals
- LNG tankers
- Container ships
- Ferries, cruise ships and ro-ro.

The nautical miles sailed by ships >2,000 tons DW within these categories in the two study areas from 01.07.2008 to 30.06.2009 are shown in Table 5-2 and

Table 5-3 below.

Table 5-2 One year sailed nautical miles in the Kattegat (1/7-2008 to 30/6-2009)

Type	Sailed distance (nautical miles)				
	2,000-10,000	10,000-20,000	20,000-60,000	60,000-100,000	100,000-320,000
Bulk & general cargo	417.004	108.469	266.212	87.978	4.631
Tankers, crude oil + chemicals	613.407	203.258	349.062	43.980	233.449
LNG tankers	48.269	4.477	16.235	0	0
Container ships	1.920.317	239.984	133.814	0	16.550
Ferries, cruise ships and ro-ro	1.056.327	288.625	14.018	0	0

Table 5-3 One year sailed nautical miles in the Århus Bight (1/7-2008 to 30/6-2009)

Type	Sailed distance (nautical miles)				
	2,000-10,000	10,000-20,000	20,000-60,000	60,000-100,000	100,000-320,000
Bulk & general cargo	1.895	667	986	150	0
Tankers, crude oil + chemicals	9.284	201	414	0	0
LNG tankers	0	0	0	0	0
Container ships	23.527	6.355	1.508	200	982
Ferries, cruise	87.974	1.700	0	0	0

ships and ro-ro					
-----------------	--	--	--	--	--

For the purpose of estimating the total amount of fuel used by ships crossing Kattegat and Aarhus Bight, respectively, also estimates of the typical speed of the ships and their power generation/fuel consumption are required.

According to the information in AIS the average speed of the vessels in Kattegat varies between approx. 15 and 18 knots for the five different categories while the engine sizes (in MW) for the different ship categories and tonnages have been estimated based on inputs from a number of sources (Table 5-4).

On average all ships are assumed to sail in Danish waters at approx. 60 % of their maximum engine capacity (MCR).

Table 5-4 Estimate of average size of engine (MW) as function of ship type and tonnage (dwt).

Type	Engine size (MW)				
<i>DWT (tons)</i>	<i>2,000-10,000</i>	<i>10,000-20,000</i>	<i>20,000-60,000</i>	<i>60,000-100,000</i>	<i>100,000-320,000</i>
Bulk & general cargo	3	5	8	12	15
Tankers, crude oil + chemicals	4	6	8	12	16
LNG tankers	5	7	10	20	30
Container ships	8	10	30	55	80
Ferries, cruise ships and ro-ro	10	20	30	-	-

Based on the figures and assumptions above it is possible to calculate the power consumed (MWh) for each of the five categories and five size classes of the ships in the above tables (see Table 5-5 and Table 5-6).

Table 5-5 Power consumption (MWh) by ships in Kattegat for the one year period.

Type	Power consumption (MWh), Kattegat				
<i>DWT (tons)</i>	<i>2,000-10,000</i>	<i>10,000-20,000</i>	<i>20,000-60,000</i>	<i>60,000-100,000</i>	<i>100,000-320,000</i>
Bulk & general cargo	50.889	22.062	86.632	42.945	2.826
Tanker, crude oil + chemicals	98.145	48.782	111.700	21.110	149.407
LNG tanker	9.654	1.254	6.494	0	0
Container	512.085	79.995	133.814	0	44.133

Type	Power consumption (MWh), Kattegat				
<i>DWT (tons)</i>	<i>2,000-10,000</i>	<i>10,000-20,000</i>	<i>20,000-60,000</i>	<i>60,000-100,000</i>	<i>100,000-320,000</i>
Ferry, cruise ships and ro-ro	369.714	202.037	14.719	0	0

Table 5-6 Power consumption (MWh) by ships in Aarhus Bight for the one year period.

Type	Power consumption (MWh), Aarhus Bight				
<i>DWT (tons)</i>	<i>2,000-10,000</i>	<i>10,000-20,000</i>	<i>20,000-60,000</i>	<i>60,000-100,000</i>	<i>100,000-320,000</i>
Bulk & general cargo	231	136	321	73	0
Tanker, crude oil + chemicals	1.486	48	133	0	0
LNG tanker	0	0	0	0	0
Container	6.274	2.118	1.508	366	2.619
Ferry, cruise ships and ro-ro	30.791	1.190	0	0	0

In the Kattegat, the total power consumption over a year was approx. 2 million MWh of which vessels <10,000 tons accounted for about 50 %, and in the Aarhus Bight the consumption was approx. 47,000 MWh of which vessels <10,000 tons accounted for more than 80 %.

To transform the MWh-figures to total amount of fuel used, a conversion factor of 180 kg fuel per MWh produced is applied. The fuel consumption for the year 01.07.2008 to 30.06.2009 then becomes:

Kattegat: 362,000 tons

Aarhus Bight: 8,500 tons

The distribution of fuel consumption on size classes and ship types is given in Figure 5-4 and Figure 5-5 below.

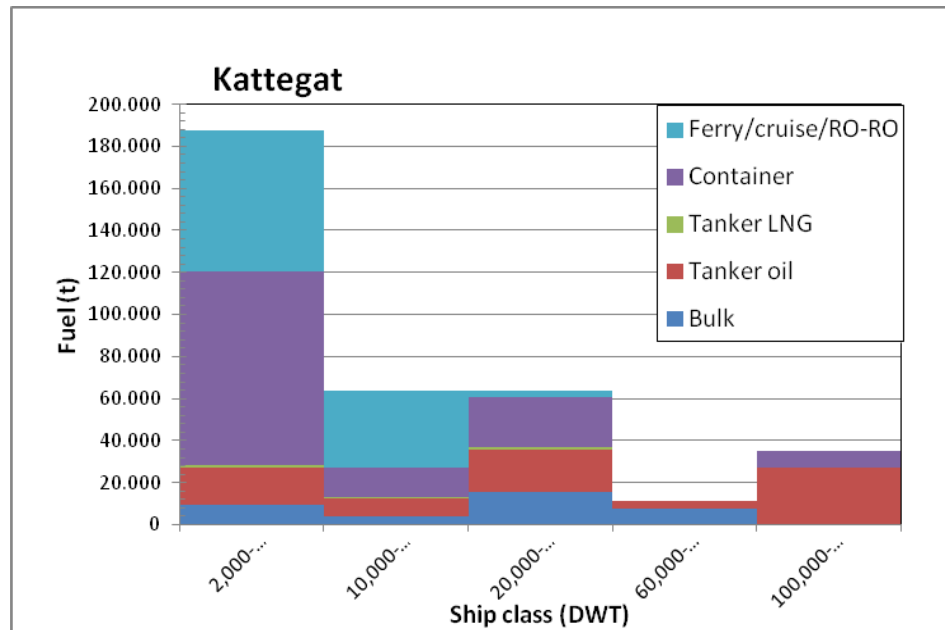

Figure 5-4 Annual fuel consumption for the Kattegat, for each ship class and ship type.(July 2008 to June 2009).

For the Kattegat the figure illustrates that more than 50 % of the fuel consumption is due to traffic by ships of less than 10,000 tons dwt and that with regard to fuel consumption ferries/cruise ships/ro-ro and container ships are the most important in the small size classes (<20,000 tons) while in the biggest class oil tankers contribute the most.

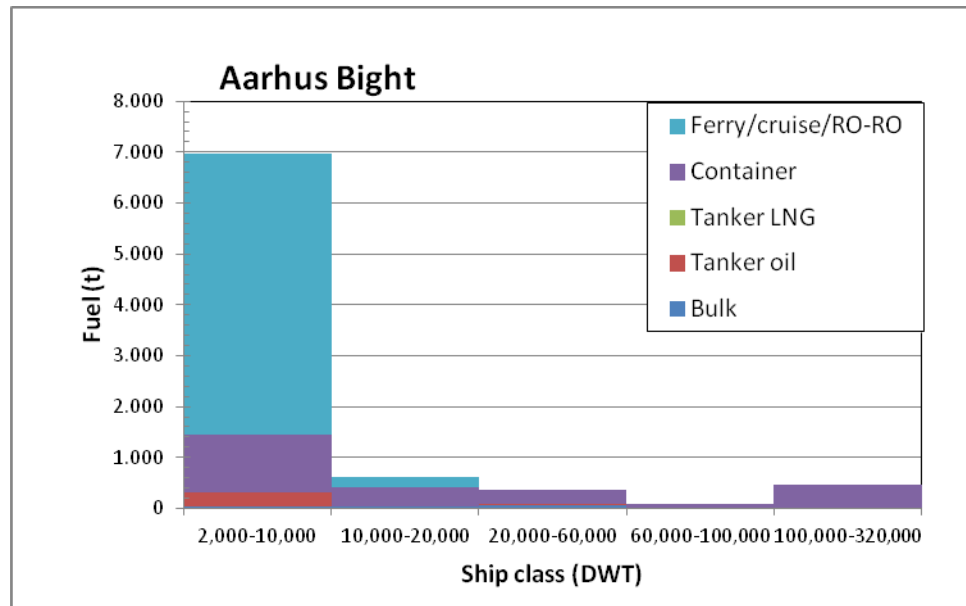

Figure 5-5 Annual fuel consumption for the Aarhus Bight for each ship class and ship type. (July 2008 to June 2009).

For the Aarhus Bight the figure illustrate that more than 80 % of the fuel consumption is due to ships <10,000 tons dwt, a class dominated by ferries, cruise ships and Ro-Ro's, while the bigger classes almost exclusively comprise container ships.

5.3 Marine impact assessment

5.3.1 "All ships" scenario

Sulphur/sulphuric acid

In section 5.2.4 the total annual fuel consumption by ships passing through the Kattegat and Aarhus bight, respectively, was estimated based on data on sailed nautical miles, average speeds and estimates of power generation. As per 1 January 2012, the maximum content of sulphur in marine fuels permitted by the IMO is 3.5%. Therefore, this value was chosen as a conservative estimate of the average sulphur concentration in the fuels used³.

Based on these assumptions and a scrubbing efficiency of 100 %, the annual total releases of sulphur and corresponding sulphuric acid equivalents from ship traffic to Kattegat and Aarhus Bight can be calculated as shown in Table 5-7.

Table 5-7 Estimated annual releases of sulphur/sulphuric acid from ship traffic to the marine environment in Kattegat and Aarhus Bight.

Area	Sulphur (kg/year)	Sulphuric acid eq. (kg/year)	Sulphuric acid eq. (kmol/year)
Kattegat	12,700,000	38,900,000	400,000
Aarhus Bight	300,000	920,000	9,300

Using the data and assumptions regarding the two model areas, Kattegat and Aarhus Bight, in combination with the release estimates, the additional concentration of sulphur/sulphuric acid originating from discharge of acid washwater to the sea water can be estimated, see Table 5-8.

Table 5-8 Estimated additional steady state concentrations of sulphur/sulphuric acid from ship traffic to the marine environment in Kattegat and Aarhus Bight.

Area	Sulphur (µg/L)	Sulphuric acid eq. (µg/L)	Sulphuric acid eq. (µmol/L)
Kattegat	6.5	20	0.20
Aarhus Bight	1.0	3.1	0.03

The sulphur concentrations presented are long term steady state surplus concentrations resulting from discharges of washwater from scrubbers, assuming that the sea area is well mixed, that the concentrations in the adjacent sea areas are negligible and that sulphur behaves conservatively (no chemical or biological reactions). The surplus concentration of sulphur due to the contribution from scrubbers will reach its steady state in the Kattegat after 8-9 months and in Aarhus Bight within less than 1 month as shown on Figure 5-6 and Figure 5-7, respectively. The figures describe a situation where the contribution from scrubbers begins at time and concentration zero and continues until the concentration has reached an almost constant level, where

³ According to IMO (MEPC 62/4, IMO 2011), the global average level of sulphur in heavy fuel was 2.6 % in 2010, and only 15 % of the fuel contained more than 3.5 % S.

the input to the sea area from scrubbers balances the output due to exchange with sea water from adjacent, largely unpolluted areas.

For comparison, in this project the background concentration of sulphur in the Kattegat/North Sea was determined to be 860-870 mg S/L (860,000-870,000 µg/L).

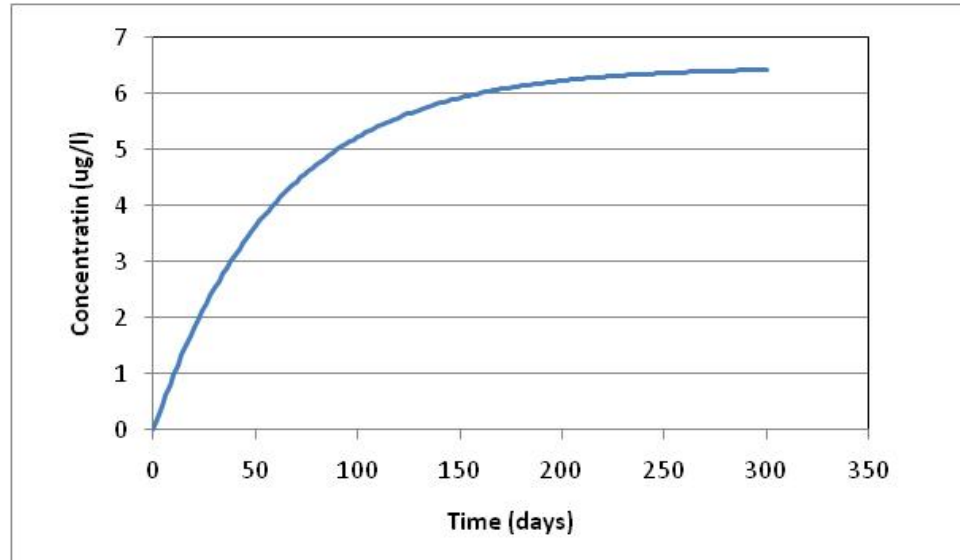

Figure 5-6 Kattegat: Development in time for the sulphur concentration due to scrubbing water.

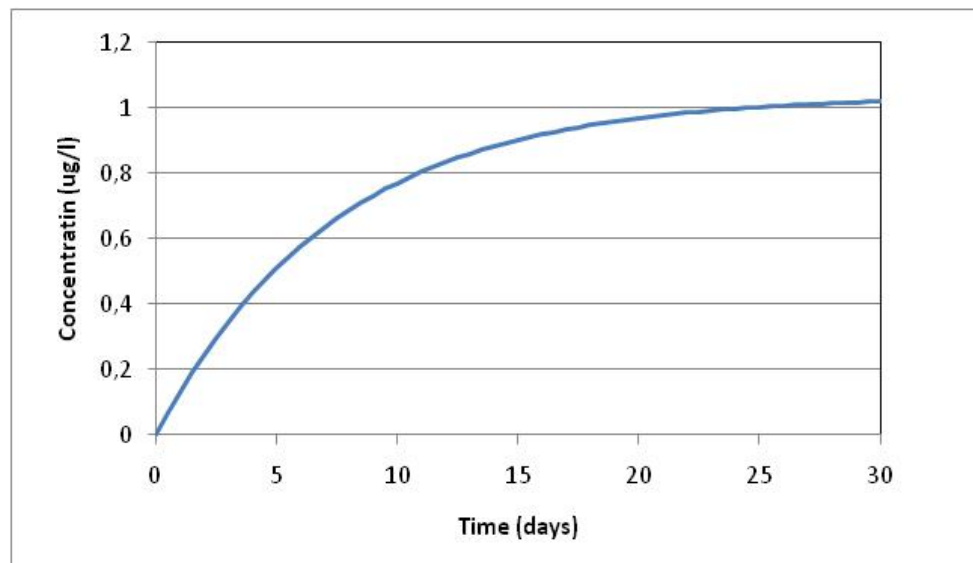

Figure 5-7 Aarhus Bight: Development in time for the sulphur concentration due to scrubbing water.

The alkalinity (buffering capacity, mainly due to the bicarbonate system) of sea water in the Kattegat is close to that of the North Sea, approximately 2.2 mmol/L (Hansen, 2011), and the amount necessary to neutralise the added sulphuric acid only makes up about 0.01 % of that capacity. Therefore, the contribution from exhaust gas scrubbers to a possible general acidification of the oceans (e.g. from the increasing level of carbon dioxide in the atmosphere) is considered to be marginal.

This assessment is extendable to brackish waters with low alkalinity such as the Bay of Bothnia (northernmost part of the Gulf of Bothnia), where the alkalinity is at least one third of that found in the North Sea and Kattegat (Henriksson, 2007). Even if the ship traffic intensity in this area was as high as in the Kattegat (which is not the case), the consumption of alkalinity to neutralise scrubber wash water would be marginal compared to the pool available.

An even more conservative scenario was run with the model to further consolidate the assessment. In addition to the sulphur load already being set at the maximum value in the main scenario (100% discharge of sulphur from fuel with 3.5% S), the ship traffic intensity based on 2008-2009 data was doubled and the average engine load increased from 60 % to 80 %, i.e., as the response of the dilution model is linear, a total increase of the impact with a factor of 2.67. This scenario shows that even if the buffer capacity was as low as in the most sensitive area in the Baltic Sea, the Bay of Bothnia, the maximum impact on the buffering capacity would be less than 0.1 %.

In conclusion, the impact of scrubber wash water discharges on the buffering capacity, and thereby on the pH of open marine waters if all ships were equipped with such systems, is assessed to be marginal. In all parts of the Baltic Sea ECA, from the North Sea to the Gulf of Bothnia there will be orders of magnitude between the impact and the buffering capacity available. This conclusion is in line with theoretical considerations and laboratory experiments by Behrends & Liebezeit (2003) and the conclusions of a risk assessment by Buhaug et al. (2006) using the Oslo Fjord as study case.

Hazardous substances

In section 5.2.2 (Table 5-1) the results on contents of hazardous substances in wash water (SW and FW) from the wet scrubber on Ficaria Seaways are summarised and compared to the relevant Environmental Quality Standards (EQS) for marine waters in the Baltic Sea ECA.

The comparison demonstrates that for most of the substances for which EQS values are established a certain dilution (mixing zone) of the wash water (SW-mode) is required before compliance is achieved. The most critical substance is copper for which a European EQS has not been established but a Danish value of 1.0 µg/L (added) exists (see Table 5-1).

The dilution of hazardous substances is determined corresponding to the analysis for sulphur above. First, the ratio between the surplus concentration of sulphur in the wash water and the steady state surplus concentration in the Kattegat is determined. Subsequently, the wash water/sea water ratio determined for sulphur is applied to the concentrations of each of the hazardous substances measured in Ficaria Seaways's wash water to obtain the steady state surplus concentrations of these substances in the Kattegat.

The resulting steady state surplus concentrations of each hazardous substance measured in the wash water are illustrated in Figure 5-8 below. The concentrations are shown as bars representing the range of wash water concentrations measured, which also illustrate the variation due to engine load and sulphur content of the fuel. The red dots indicate the annual average EQS (AA-EQS).

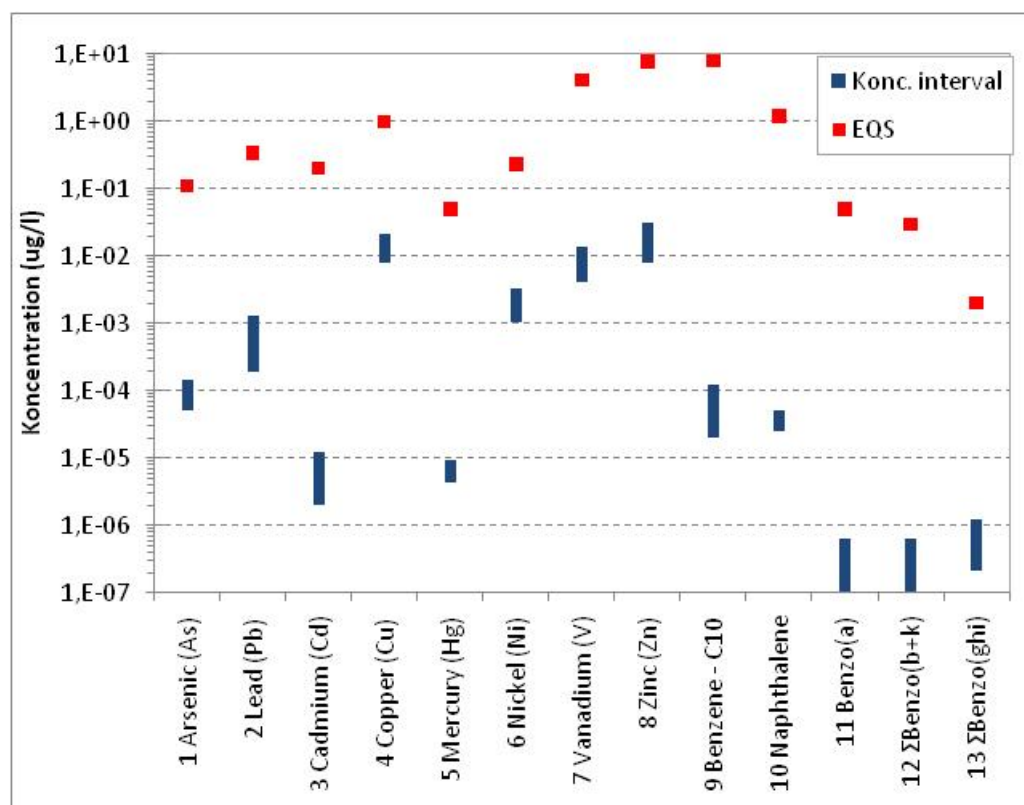

Figure 5-8 Long term concentration in the Kattégat. The interval of the blue bars represent the variation in the analytical results. The red dots illustrate the EQS. Note that the y-axis is logarithmic. This indicates that the expected sea water concentrations and the EQS typically differ by 2 to 3 orders of magnitude.

The resulting concentrations in sea water are given in Table 5-9 below. For the sake of simplicity, the results are only given as "typical" values, or order of magnitude for the Kattégat area. The most stringent EQS values in Table 5-1 are included for comparison.

Table 5-9 Expected concentrations of hazardous substances in the Kattégat

Substance	Expected surplus Concentration (µg/L)	EQS (min) (µg/L)
Arsenic (As)	0.00007	0.11
Lead (Pb)	0.0006	0.34
Cadmium (Cd)	0.00001	0.2
Copper (Cu)	0.01	1
Mercury (Hg)	0.000005	0.05
Nickel (Ni)	0.002	0.23
Vanadium (V)	0.007	4.1
Zinc (Zn)	0.02	7.8
Benzene - C10	0.0001	8
C10 - C25	0.003	-

Substance	Expected surplus Concentration (µg/L)	EQS (min) (µg/L)
C25 - C35	0.004	-
Sum, benzene-C35	0.006	-
ΣPAH	0.00005	-
Naphthalene	0.00003	1.2
Benzo(a)pyrene	0.0000005	0.05
ΣBenzo(b+k)fluoranthene	0.0000005	0.03
ΣBenzo(ghi)perylene + Indeno(123-cd)pyrene	0.000001	0.002

The values in Table 5-9 indicate that almost all the hazardous substances discharged with wash water are expected to occur in concentrations 3-6 orders of magnitude lower than the EQS and thereby far from known biological effect levels. The substances with the highest concentrations compared to the EQS are copper and nickel. However, the concentrations of these two substances may be significantly over-estimated due to possible sample contamination (see section 4.3.2).

Regarding the oil components for which no European or Danish EQS exist, a comparison with OSPAR's limits for discharge of produced water from oil/gas installations in the North Sea can be made. The current limit is 30 mg/L, i.e. at least 100 higher than the total content of THC found in Ficaria Seaways's wash water.

To further support the above conclusion that the concentrations of hazardous substances occurring in the open seas as a result of scrubber water discharges are far from ecological concern levels, an additional assessment has been made using even more conservative input values to the model than for the main scenario above. The revised values for the model are shown in Table 5-10 below.

Table 5-10 Additional "worst case" scenario for hazardous substances - revised factors for key processes in the hydrographic dilution model.

Process	Conservative assumption	Factor
Sampling and chemical analysis	Uncertainty of 25 % on both	1,5
Ship traffic	Intensity may be doubled	2
Engine load and performance	Load from 60% to 80%, poorer performance of engines	2
Fuel purity	Higher level of contaminants in fuel oil	2
Total		12

As the applied dilution model gives a linear response to changes in the above input parameters an increase in the load of 12 times will lead to a corresponding increase in the predicted sea water concentrations. Even in this situation, none of the resulting concentrations will exceed their corresponding EQS value.

It is noted that for an actual environmental risk assessment of the relevant chemical substances in a particular area the cumulative level and load from all sources in that area (e.g. sewage effluents, runoff, atmospheric fallout) must be taken into account.

Long term considerations

Background concentrations

The above calculations are carried out under the assumption that the background concentration of a substance is constant. However, this may not be the case if the input to the system is continuous during long periods and the substance is conservative and can accumulate in the environment.

The time scale model used for the impact assessment is, as explained in section 6.1.3, a stationary model which calculates the "surplus concentration" over the background concentration in the stationary situation, i.e. over a very long time span. The assumption of the model is, however, that the background concentration remains unchanged. This is the concentration in the adjacent sea areas that exchange water with the area concerned, i.e. for the Kattegat this is the North Sea. Therefore, as long as the concentration in the North Sea does not increase, the concentration in the Kattegat will not slowly increase either. Since the North Sea has a very intense water exchange with the Atlantic Ocean being characterised by very low background levels of contaminants and a huge volume of water, it is unlikely that the background levels in the North Sea should change significantly within a foreseeable future.

Dissolved versus particle-bound substances

The assessment in this chapter generally assumes that the hazardous substances remain dissolved in the water phase and eventually are distributed evenly in the sea. This is true e.g. for sulphuric acid but many metals and organic pollutants tend to adhere to particles and settle according to the result of physical processes such as sedimentation, re-suspension and advection. This means, that the substances in reality will have a shorter history in the water column than assumed above and a significant fraction eventually will be deposited on the sea bed (in sedimentation areas).

If, for example, a conservative substance "X" has a concentration in the wash water of 10 µg/L (SW-mode), the total annual load of that substance to the Kattegat will be 1000 kg per year. If 50 % of this amount settles on the sea bed (the other 50 % either remain in the water phase or are "exported" to the North Sea) in sedimentation areas, and these constitute 50 % of the total surface of the Kattegat, then the accumulation rate of "X" will be 45 µg/m²/year or approx. 0.6 µg/kg sediment/year (assuming even distribution in the upper 5 cm). For most substances this is much lower than known effect levels for sediment-dwelling organisms (for comparison: the same mean concentration of a substance occurring in municipal wastewater effluent would result in an approx. 8 times higher total discharge from Danish sewage treatment plants).

Concentration gradient along shipping lanes

Since the advective velocities (currents) in the Kattegat are in the scale of 10⁻¹ m/s and the settling velocities in the scale of 10⁻⁵ m/s, a particle will typically drift 2•10⁵ m = 200 km before it can settle at the sea bed at 20 m's depth. Since the dimensions of the Kattegat is of the same order of magnitude it can

be assumed that the particles released from the ships will settle throughout the entire Kattegat, primarily in the typical sedimentation areas, and in general not significantly concentrate along the main shipping routes.

Other areas in the Baltic Sea

The present study includes the Kattegat and the Aarhus Bight. For water bodies within the Baltic Sea south of the Danish straits, the exchange with the open oceans is limited. However, the residence time for the upper layers of the Baltic Sea is 5-10 years. If the deeper regions of the Baltic Sea are included, the residence time is about 30 years. Within this time horizon, the concentration of any of the relevant substances due to discharge of scrubber washwater is not likely to increase to levels of concern in the Baltic Sea region. It must also be remembered that the ship traffic intensity is lower than in the Kattegat, especially in the northern parts of the Baltic Sea.

Effect of atmospheric deposition

The above considerations focus on the direct input of contaminants from scrubbers to the marine environment. When the effects of the scrubbers are compared with a situation with no scrubbers, one has to keep in mind that a substantial part of the substances emitted to the atmosphere with the exhaust gas eventually, irrespective of scrubber use or not, will be deposited on the sea and hence will contaminate the marine environment.

5.3.2 "One ship" scenario

The "one ship" scenario aims to identify possible local impacts on the marine environment of scrubber wash water discharged from a single ship of a size resembling Fincantieri Seaways.

For this scenario it is relevant to consider the size of the mixing zone, which can be defined as the zone around the source inside which the EQS for the substance of concern is exceeded. Since the mixing processes in the vicinity of a ship in motion are highly complex, it is assumed in the following that the discharge of wash water from the scrubbing process containing sulphuric acid and hazardous substances is mixed by the propeller within the wake of the ship. The wake is assumed to have approximately the same dimension as the cross section of the ship.

If assuming the representative ship has a width of 20 m, a draft of 10 m, a speed of 15 knots and an engine load of 60% of 20MW = 12MW, the resulting concentration in the wake just behind the ship can be calculated.

Sulphur

For sulphur, the calculations are based on the relations between engine fuel consumption and sulphur discharge assuming a sulphur content in the fuel (HFO) of 3.5 % and complete conversion of the sulphur to sulphuric acid.

Under these assumptions a representative ship would discharge wash water with a concentration of approx. 130 mg sulphuric acid/L leading to a concentration of sulphuric acid in the wake of about 40 µg/L. This corresponds to less than 0.5 µmol/L and the load is thereby far below the buffering capacity (alkalinity) of sea water in Kattegat or anywhere in the Baltic Sea ECA area. Thus, the risk of local effects of sulphuric acid releases to the marine environment is considered to be negligible.

A worst case situation, a large ship with twice the engine size of Ficaria Seaways (i.e. 40 MW) operating at 80% MCR, will result in a maximum concentration of sulphuric acid of about 1 µmol/L, i.e. still far below the buffering capacity of sea water anywhere in the Baltic Sea ECA.

Hazardous substances

The calculations for the hazardous substances in the "one ship" scenario are also based on the concentrations measured in the wash water from Ficaria Seaways.

The results are shown in Table 5-11 below. The results are compared with the EQS and for clarity, a column is added that indicate the ratio between the calculated concentration and the EQS. As long as this ratio is below unity (1), the EQS requirement is met.

In order to be on the safe side the highest measured wash water concentrations and the lowest EQS values are selected for the present analysis.

Table 5-11 Results of mixing zone concentrations in the wake just behind the ship.

Substance	Washwater (max) (µg/L)	Emission (µg/s)	Wake conc. (µg/L)	EQS (min) (µg/L)	Ratio Conc./EQS
Arsenic (As)	1.8	5.0E+02	3.2E-04	0.1	3.2E-03
Lead (Pb)	21	5.8E+03	3.8E-03	0.34	1.1E-02
Cadmium (Cd)	0.2	5.6E+01	3.6E-05	0.2	1.8E-04
Copper (Cu)	260	7.2E+04	4.7E-02	1	4.7E-02
Mercury (Hg)	0.099	2.8E+01	1.8E-05	0.05	3.6E-04
Nickel (Ni)	43	1.2E+04	7.7E-03	0.23	3.4E-02
Vanadium (V)	180	5.0E+04	3.2E-02	4.1	7.9E-03
Zinc (Zn)	450	1.3E+05	8.1E-02	7.8	1.0E-02
Benzene - C10	2	5.6E+02	3.6E-04	8	4.5E-05
C10 - C25	160	4.4E+04	2.9E-02	-	-
C25 - C35	170	4.7E+04	3.1E-02	-	-
Sum, benzene-C35	330	9.2E+04	5.9E-02	-	-
ΣPAH	1.8	5.0E+02	3.2E-04	-	-
Naphthalene	0.57	1.6E+02	1.0E-04	1.2	8.5E-05
Benzo(a)pyrene	0.032	8.9E+00	5.8E-06	0.05	1.2E-04
ΣBenzo(b+k)fluoranthene	0.01	2.8E+00	1.8E-06	0.03	6.0E-05
ΣBenzo(ghi)perylene + Indeno(123-cd)pyrene	0.042	1.2E+01	7.6E-06	0.002	3.8E-03

It is seen from Table 5-11 that the requirements are met in the wake of the ship for all substances for which EQS have been established. In a typical release of polluted water, e.g. an urban sewage effluent, a mixing zone of limited size is defined where it is accepted that the requirements to pollutant concentrations are not met.

In the case of a ship in motion, such a mixing zone will extend somewhere between the discharge pipe of the wash water and the propeller of the ship. This means that the necessary mixing zone is limited to a fraction of the ship length, the thickness of the turbulent boundary layer beside the ship (few meters) and the width of the turbulent plume of released water (few meters).

Therefore, it is assessed that the discharge of hazardous substances with the wash water from exhaust gas scrubbers on a single ship will result in local concentrations in the sea water that are several times below the accepted biological no-effect levels (as reflected by the European or Danish EQS values). Hence, the risk of local effects of hazardous substances in scrubber water is considered to be very low.

5.3.3 "No scrubbers" scenario

In the "no scrubbers" scenario no ships have exhaust gas scrubbers installed but instead comply with the IMO requirement by converting to low sulphur fuel (max. 0.1 % S) by 2015.

Sulphur

In the "all ships" scenario it was calculated that 362,000 tons of fuel were consumed for power generation by ships sailing in the Kattegat area. In the scenario a content of sulphur in the fuel of 3.5 % was assumed.

In the "no scrubbers" scenario all ship traffic data are identical with the "all ships" scenario except for the fuel, which in this scenario only contains 0.1 % S, i.e. only 2.85 % of the amount in the "all ships" scenario. In other words, where the "all ships" scenario leads to a total annual discharge of 12,670 tons sulphur into the marine environment, the "no scrubbers" scenario results in discharge of only about 360 tons sulphur in the sea. This amount is considered absolutely negligible in relation to risk of consumption of sea water buffering capacity and acidification of marine areas.

Hazardous substances

With regard to most of the hazardous substances the content of sulphur in the fuel oil and the content of the hazardous substances do not appear to be correlated. The exceptions from this are the metals nickel and vanadium for which the results shown in Table 4-3 clearly indicate a correlation.

Hence, for these two substances the "no scrubbers" scenario results in a direct load on the marine environment that is significantly smaller than in the "all ships" scenario. For the other substances the main difference between the two scenarios is that some of the load will be released locally to sea water with scrubber wash water in the "all ships" scenario while in the "no scrubbers" scenario this load will be dispersed via the atmosphere thus not appreciably resulting in elevated concentrations locally. In summary, the "no scrubbers" scenario results in lower discharges of sulphur, nickel and vanadium to the marine environment than in the "all ships" scenario in which the levels have

been demonstrated to be far from ecological concern levels. On the other hand, the on-shore desulphurisation of fuel oil requires a considerable input of energy probably exceeding that needed for operating the exhaust gas scrubbers at sea (Hansen, J.P., Alfa Laval DK (2011), pers. comm.).

5.3.4 Use of exhaust gas scrubbers in ports

While being in port most ships use auxiliary engines to provide electricity and power for e.g. heating of crew and passenger areas, cooling of sensitive cargo or pumping of water etc. The exhaust gases could very likely be cleaned by scrubbing to reduce emissions of particulates and other contaminants. The power supplied by auxiliary engines can vary considerably but for the sake of this assessment an average of 1 MW is assumed (Ficaria Seaways produces about 0.7 MW), which leads to discharge of approx. 50 m³ scrubber water/hour.

Additionally, some ships are equipped with so-called inert gas scrubbers, which primarily are used on crude oil tankers where inert gas is needed to replace the oil being pumped out of the tanks. According to information from Alfa Laval, Aalborg, DK (Hansen, J.P., pers. comm.), an average inert scrubber gas unit consumes 880 kg fuel/hour and 210 m³ of sea water/hour, and typically operates for 24-48 hours (average = 36 hours).

As an example, Aarhus Port has a surface area of water within the breakwaters of at least 2 km² and if an average depth of 10 m is assumed this corresponds to a volume of 20 million m³. The port has about 3,000 arrivals per year of ships larger than 2,000 tonnes DWT of which just over 400 are tankers of various categories (crude oil, chemicals and other non-food products).

If looking at an average situation, about 10 ships will be in Aarhus Port at a time of which one will be a tanker with an inert gas scrubber. Over a 24 hours period the ships will discharge 10 x 50 x 24 = 12,000 m³ scrubber water and 5,000 m³ of inert gas scrubber water, i.e. a total of 17,000 m³/day compared to the total volume of the port of 20 million m³ corresponding to a dilution factor of almost 1,200 if assuming complete mixing. However, in reality the mixing processes inside a port and the exchange of water between the port and the surroundings take place slower than in the open sea thus leading to an in practice achievable dilution being significantly lower than in the ideal mixing situation.

Therefore, although the releases of acidity and hazardous substances from exhaust gas scrubbers operating in SW-mode in a port are not assessed to lead to violation of the EQS in the short term, the uncertainty about the possible increases in concentrations with time gives some concern about the situation in the long term. A precautionary approach to this would be to allow only the use of FW-scrubbers (circulation scrubbers) or the use of low sulphur (0.1 %) fuels on ships in ports.

6 Scrubber waste treatment and disposal

6.1 Characteristics of scrubber sludge

A general description of sludge production from operation of wet scrubbers is given in section 3.2.1.

Data on sludge generation and composition are not frequently found in relevant literature as it seems the strongest focus so far has been on scrubber cleaning performance and wash water composition. However, Wärtsilä (2010) report on the following findings regarding sludge in the study report of their scrubber system on board MT "Suula":

The amount of generated sludge is approximately 0.1 to 0.4 kg/MWh. Samples of sludge produced on board the MT Suula when using 1.5% sulphur fuel have been extracted and analysed. The results of the analyses show that scrubber sludge contains water (79%) and dry matter (dm; 21%). The composition of the sludge is mainly oil hydrocarbons (252 g/kg dm), ash (i.e. various inorganic constituents; 59 % of dry matter) and metals (53 g/kg dm). The water emulsion contains hydrocarbons, metals and sulphate. Sludge quantity and quality depend on fuel oil quality. Coagulation and flocculation chemicals are added in the bleed-off treatment processes and the composition of such chemicals is reflected in the sludge analyses.

Ritchie et al. (2005) indicate a sludge generation of 0.2 kg/MWh from the seawater scrubber onboard the ferry Pride of Kent. However, the reporting on the composition of this sludge is so incomplete that no assessment can be made.

The composition of sludge generated by the wet scrubber installed on Ficaria Seaways, when operated in circulation mode with freshwater, is presented in section 4.3.4. The dry matter content is lower (11 %) than that reported by Wärtsilä (2010) but can, by use of a more effective centrifuge, easily reach the same level as found onboard the MT "Suula". Ash content is the same while contents of THC and metals appear to be somewhat lower in the sludge from Ficaria Seaways. However, it is not specified which metals are included in the sum of metals in the sludge from "Suula", if this figure includes metals like e.g. iron and manganese (that were not included in the analyses of Ficaria Seaways's sludge) the levels could very well be very similar. PAH appears to be the environmentally most important constituent of the sludge generated onboard Ficaria Seaways.

6.2 Treatment and disposal options

6.2.1 Waste classification

The waste from operation of wet exhaust gas scrubbers on ships to be collected and temporarily stored onboard for subsequent on-shore treatment/disposal comprises two main categories:

- Used, centrifugated wash water from scrubbing with circulated freshwater (FW-waste)
- Sludge (from operation in either SW- or FW-mode)

According to the European Waste Code (EWC) such types of waste shall be classified according to one of the following codes:

16 10 aqueous liquid wastes destined for off-site treatment

16 10 01* aqueous liquid wastes containing dangerous substances (M)

16 10 02 aqueous liquid wastes other than those mentioned in 16 10 01

16 10 03* aqueous concentrates containing dangerous substances (M)

16 10 04 aqueous concentrates other than those mentioned in 16 10 03

From this follows that depending on the content of hazardous substances the FW-waste should be classified either code 161001 or 161002.

Likewise the sludge waste has either codes 161003 or 161004.

The sulphur absorbed by the scrubbing process will, due to the neutralization of pH by sodium hydroxide, be present in the waste as sodium sulphate (Na_2SO_4), which is not considered a hazardous substance in any case.

Table 6-1 shows the limiting content for classification as non-hazardous or hazardous waste of the measured heavy metals and organic pollutants in FW-waste and sludge based on ESIS-Classification and Labelling (2011).

Table 6-1 The limiting content for hazardous waste compared to the contents observed in liquid FW-waste and sludge on Ficaria Seaways.

Chemical substance	%	Limit value mg/Lor mg/kg	Liquid FW-waste (HFO, 2.2 % S) mg/L	Sludge waste (HFO, 2.2 % S) mg/kg
Sulphur (total)			9	79,000
Arsenic (As)	3	30,000	0.0098	8.4
Lead (Pb)	0.05	500	0.0038	54
Cadmium (Cd)	0.01	100	0.000094	0.080
Copper (Cu)	20	20,000	0.86	1,100
Mercury (Hg)	0.05	500	<0.00005	<0.050
Nickel (Ni)	0.1	1000	3.1	5400
Vanadium (V)	1	10,000	14	12,000
Zinc (Zn)	5	50,000	0.42	260
Benzene - C10	0.1	1000	0.016	85
C10 - C25	0.1	1000	4.4	54,000

Chemical substance	%	Limit value mg/Lor mg/kg	Liquid FW-waste (HFO, 2.2 % S) mg/L	Sludge waste (HFO, 2.2 % S) mg/kg
C25 - C35	0.1	1000	6.6	57,000
Sum, benzene-C35 (THC)	0.1	1000	11	111,000
PAH (16 USEPA)	0.1	1000	0.0038	230
Benzo(a)pyrene	0.01	100	<0.000010	12
PCB	0.005	50	N/A	<0.001
PCDD/PCDF solid		0.015	N/A	0,000026

As appears from Table 6-1, the liquid FW-waste is not to be classified as hazardous waste, while for the sludge the contents of nickel, vanadium and THC exceed the limits for classification as hazardous waste.

6.2.2 Waste treatment

According to EU's Landfill Directive (1999) liquid, leaching and reactive waste types cannot be landfilled, but must be contained in storage facilities until such time that treatment facilities are implemented.

In the case this implies that when liquid FW-waste is transferred from a vessel to a reception facility on-shore it must be stored until it can be sent to final treatment in a wastewater treatment plant. As the pH of the FW-waste is about 6-7, the standard treatment of this type of liquid waste would be to add lime (pH=10-14) to precipitate the heavy metals, subsequently filterpress the sludge, and finally send the "clean" water to a sewage treatment plant. The generated sludge will after passing a filterpress look solid but does contain 30-40 % water, which however is sufficiently for the sludge to be placed in a landfill. The decision on final disposal of the sludge will depend on the result of a leaching test as stipulated by the Directive for Acceptance Criteria of Waste at Landfills (2003), which also describes how and where the waste should be disposed of depending on the result of the test.

The waste can either be placed in a landfill for non-hazardous waste or in a landfill for hazardous waste irrespective if the waste is classified as hazardous, that all depends on the leaching behaviour of the waste (see Article 2.3 in the Landfill Acceptance Criteria Directive).

6.2.3 Transport requirements

Due to the contents of nickel, vanadium and petroleum hydrocarbons it was assessed that the sludge should be classified as hazardous waste and, consequently, it needs to be determined how the waste can be transported in accordance with ADR [international rules for road transport of dangerous goods]. It is however estimated that the sludge will not have to be transported as dangerous goods.

6.3 Reception facilities in Danish ports

The following is based on a survey of information on the homepages of a number of Danish ports receiving vessels having a size relevant for installation of scrubber technology, combined with direct contact to a few port authorities. The Association of Danish Ports has informed that they do not possess any statistics or overview of the situation regarding this issue.

The outcome of inquiries to the two biggest ports in Denmark, Copenhagen and Aarhus, are useful as examples of the situation:

Port of Aarhus

In the Port of Aarhus, the waste-handling company H2O Liquid Waste has informed (spring 2011) that most Danish ports have vacuum truck services collecting slop oil and spill oil from ships entering the ports. Considering the nature and characteristics of scrubber wastes, this service could easily be extended to also include sludge from cleaning of exhaust gases on ships. From the point of the vacuum truck company it would be preferred to receive sludge that is pumpable (and not solid). All vessels above 20 gross register tons are obliged to deliver their waste.

To exemplify the cost of transportation and treatment of exhaust gas scrubber waste the following indicative figures can be given:

The waste handling company uses a 32 tons truck (the biggest on the market) for which the cost of operation is 750 DKK/hour (e.g. the collection of 2 m³ sludge is estimated to take half an hour). The cost of treatment is roughly estimated to be of the magnitude of 1000 DKK/ton, all depending of to which port the delivery takes place. The bigger Danish harbours all have access to vacuum truck service (e.g. Fredericia, Aarhus, Grenaa, Frederikshavn, Copenhagen).

If the sludge has to be transported from e.g. Aarhus to Kommunekemi for treatment, the cost of the transportation of 32 tons would be approx. 5-6000 DKK or about 200 DKK/ton + treatment cost of about 1750 DKK/ton.

Establishing reception tank facilities in every port is not considered feasible as that would be much too costly.

Port of Copenhagen

Initially it should be mentioned that waste of this type (liquid waste substances in bulk) is not taken care of by the Port of Copenhagen, this is a matter directly between an approved contractor (vacuum truck service) and the vessel (owner).

A list of companies that, as of 1 January 2011, were registered by the Centre for Environment, Copenhagen Municipality for the transportation of such liquids is included as Appendix 4 to the guideline. Collection, which must be made in collaboration with the Port, must as far as possible be notified one week in advance, and must enclose a completed declaration.

However, Copenhagen/Malmoe Port has issued a guideline for reception of waste called: "Recipient scheme for operating waste from ships in Port of Copenhagen" (2011). For FW-waste the following rules may apply:

Residues of noxious and hazardous liquid substances transported in bulk - chemicals: Noxious and hazardous liquid substances are defined as agents covered by Executive Order 47 of 7 April 2008 on the classification, categorization, and discharge of noxious and hazard liquid substances transported in bulk (the discharge list). The list is regularly updated. Noxious and hazard liquid substances must be declared in accordance with applicable conventions.

Reception facilities: Waste of this kind, including prewashing, is delivered to the cargo recipient / shipper in accordance with an agreement thereon with the companies currently operating in the Port of Copenhagen as importers of noxious and hazard liquid substances in bulk.

Collection times: Collection will occur within the period specified by the recipient.

Ordering of collection: In case the recipient /shipper cannot collect residues and mixtures of liquid agents transported in bulk, the Port may nominate a recipient for an amount corresponding to that specified in the vessel's P&A manual as necessary for the prewashing of the relevant tanks.

Cost: The waste contractor company Lyngholm Kloakservice I/S informs (spring 2011) that a normal price for fetching liquid bulk waste in Copenhagen Port is 1000 DKK/hr (+VAT) and that the transfer of 2 m³ liquid waste from Copenhagen port to SMOKA (the transfer station of the chemical treatment company Kommunekemi) would take 2-3 hours.

Conclusion:

Most ports in Denmark have the relevant facilities for reception of FW-waste and sludge from exhaust gas scrubbers. The cost of collection, transportation and possible treatment of the waste depends on the availability of a proper vacuum truck service and on the proximity of proper treatment facilities for the waste types in question. However, if no appropriate regional treatment facility exists, the waste can be transported to the central hazardous waste treatment company in Denmark, Kommunekemi, for treatment and final disposal.

7 Literature

Behrends, B. and Liebezeit, G. (2003). Reducing SO_x and NO_x Emissions from Ships by a Seawater Scrubber. Report, Research Centre Terramare, Wilhelmshaven, Germany.

Buhaus, Ø, Fløgstad, H. and Bakke, T. (2006). MARULS WP3: Washwater Criteria for seawater exhaust gas-SO_x scrubbers. MARINTEK REPORT MT26 A06-221. Report to Norwegian Shipowners' Association.

Couple Systems, (2010). The very new exhaust gas cleaning system, Bardowick, Germany.

Gregory D, West M, (2010). EGCSA Handbook (Exhaust Gas Cleaning Systems Association), London, UK.

Hamworthy (2007). Moss Flue Gas System, Inert Gas Systems. Moss, Norway.

Hamworthy Krystallon (2007). Sea water scrubbing - does it contribute to increased global CO₂ emission? Littlehampton, United Kingdom.

Hansen, J.P. (2011). Alfa-Laval, Aalborg, Denmark (formerly Aalborg Industries). Personal communications throughout 2011.

Henriksson, T. (2007). SO_x scrubbing of marine exhaust gases. Wärtsilä Technical Journal 02.2007, pp. 55-58.

Høy-Petersen N. (2011). Answers to specific questions and general information from Clean Marine, Oslo, Norway. www.cleanmarine.com.

Kort & Matrikelstyrelsen (2000). "Det digitale søkort", Kort & Matrikelstyrelsen, København NV, 2000.

MAN Diesel (2009). Exhaust Gas Emission Control Today and Tomorrow. Copenhagen, Denmark.

MEPC (2007). 56/INF.5. Prevention of air pollution from ships - Washwater discharge criteria for exhaust gas-SO_x cleaning systems.

MEPC (2008). MEPC 58/23 Annex 16: Report of the Maritime Environment Protection Committee on its fifty-eight session. International Maritime Organisation.

MEPC (2009). RESOLUTION MEPC 184(59). Annex 9: 2009 Guidelines for exhaust gas cleaning systems. Adopted on 17 July 2009.

Nielsen, M.,H. (2000). "Dynamisk beskrivelse og hydrografisk klassifikation af Den Jyske Kyststrøm" DANISH

METEOROLOGICAL INSTITUTE, SCIENTIFIC REPORT, 00-15. Copenhagen 2000, <http://www.dmi.dk/dmi/sr00-15.pdf>

Poulsen, O. (1991). "Skagerrak-frontens dynamic, Hydrografien i Skagerrak og Kattegat" Havforskning fra Miljøstyrelsen, Nr. 7, <http://www2.mst.dk/Udgiv/publikationer/1991/87-503-9325-1/pdf/87-503-9325-1.pdf>

Reynolds K. (2011). Exhaust Gas Cleaning Systems Selection Guide. Ship Operations Cooperative Program, U.S. Department of Transportation, Elliot City, MD.

Ritchie A, de Jonge E, Hugli C, Cooper D (2005). Service Contract on Ship Emissions: Assignment, Abatement and Market-based Instruments, Task 2c-SO₂ Abatement. European Commission Directorate General Environment.

Sømod, B. (2005). "Vandrammedirektivet Basisanalyse , Del 1, 2004, Metoder til typologisering af kystvande", Århus Amt, 2004 (in Danish) <http://www2.blst.dk/download/aar/aaa/www/pdf/basis-2005-bilag-typologi-supp-metodebesk-samlet-bilag.pdf>

Wärtsilä (2010). Exhaust Gas Scrubber installed onboard MT "Suula". Public test report.

Young, J.D. (2011). Test Report on the MS Zaandam, September 1st, 2010. Report, Hamworthy Moss AS, Norway. 05.01.2011.

Summary

Scrubber systems with the aim to clean exhaust gas from ships has been developed and is expected to be used more intensely in the near future. This study is carried out with the main objective to assess the possible impacts of scrubber water discharges on the marine environment based on a practical investigation and a literature review.



Danish Ministry of the Environment
Environmental Protection Agency

Strandgade 29
DK - 1401 København K
Tlf.: (+45) 72 54 40 00

www.mst.dk